

ANIMALETTI! SEMPLICI! ORIGAMI!

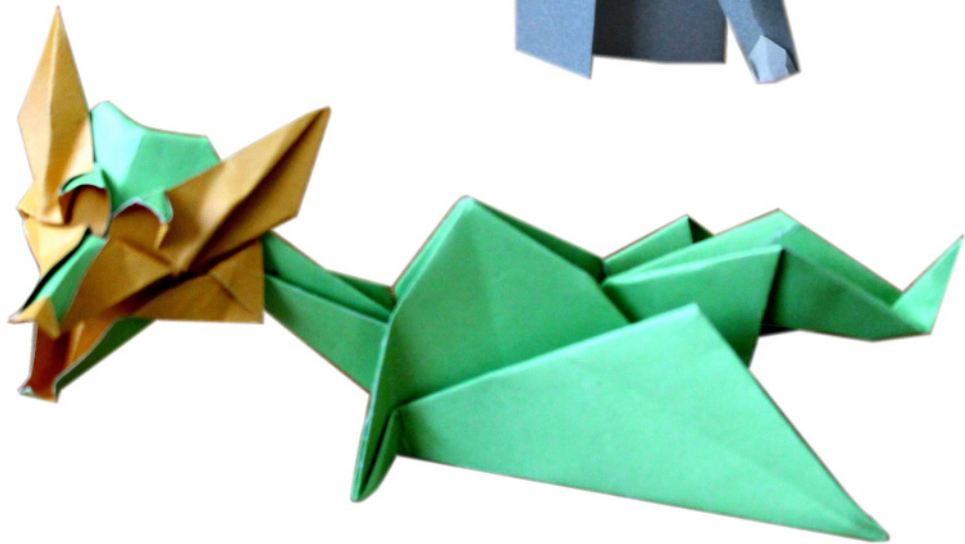

24 06 2020

Franco Peverin

Simbologia

SYMBOLOLOGY



Piegata a valle

Valley fold

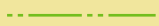

Piegata a monte

Mountain fold



Ruotate e piegate

Forward folding



Ruotate, piegate
e riportate alla
posizione iniziale

Backward Folding
Fold and Unfold



Ribaltate
sull'asse verticale

Turn the paper over
the vertical axis



Ribaltate sull'asse
orizzontale

Turn the paper over
the horizontal axis



Ruotate di 180°

Rotate 180°

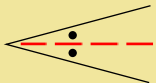

Piegata bisettrice
a valle

Bisecting valley fold



Figura ingrandita

Enlarged figure

Indicazione

Figure

Risultato 3D

3D figure

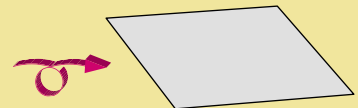
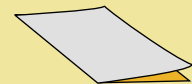
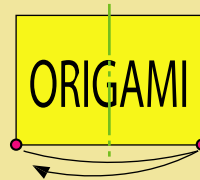

ORIGAMI



ORIGAMI

Realizzazione delle pieghe rovesce

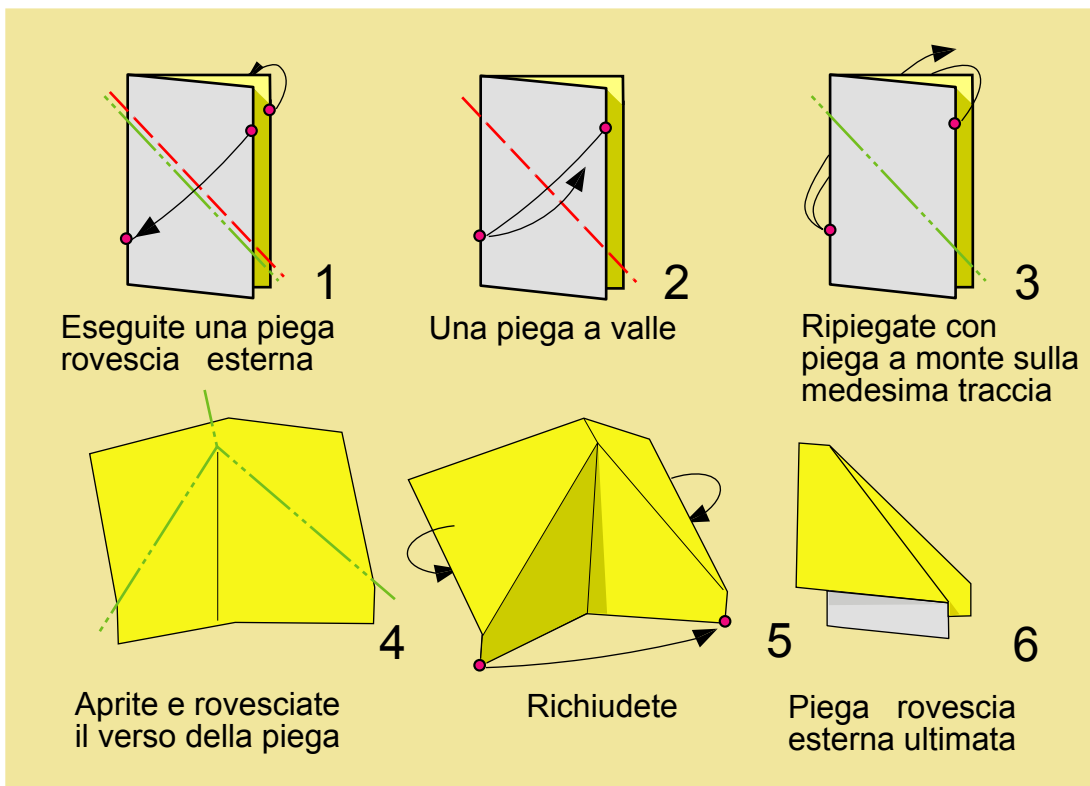
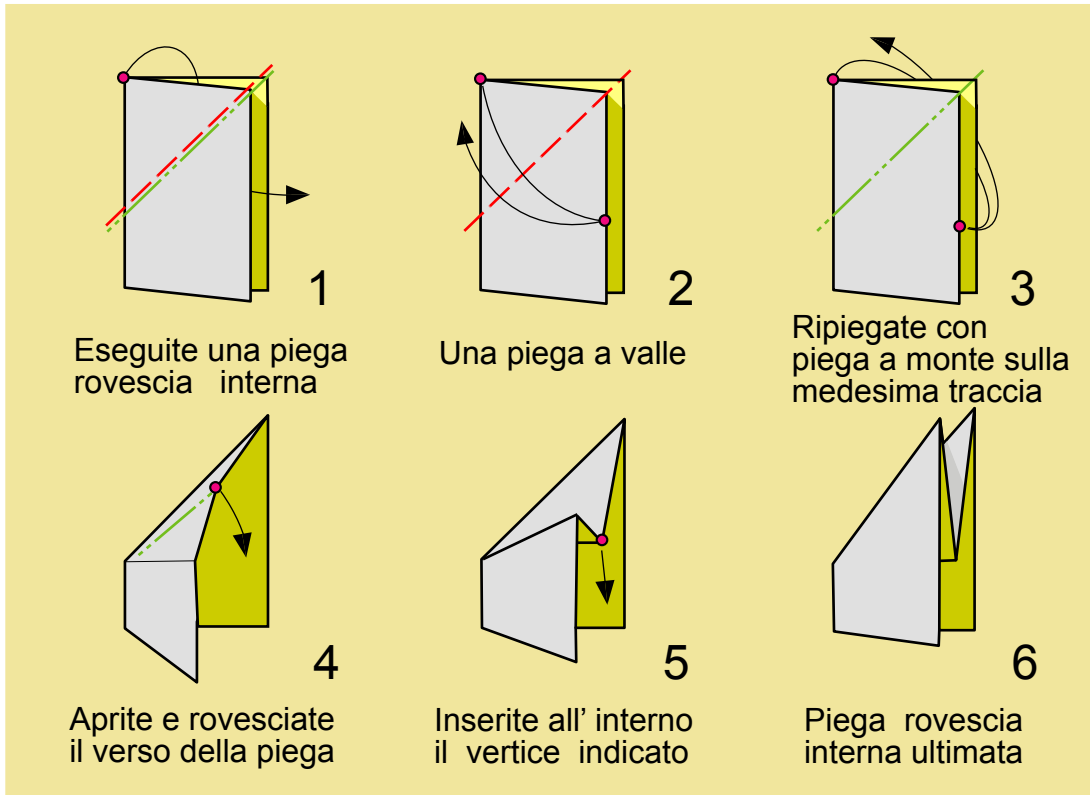

Realizzazione delle pieghe rovesce

1
Eseguite una piega rovescia interna

2
Una piega a valle

3
Ripiegate con piega a monte sulla medesima traccia

4
Aprite e rovesciate il verso della piega

5
Inserite all' interno il vertice indicato

6
Piega rovescia interna ultimata

1
Eseguite una piega rovescia esterna

2
Una piega a valle

3
Ripiegate con piega a monte sulla medesima traccia

4
Aprite e rovesciate il verso della piega

5
Richiudete

6
Piega rovescia esterna ultimata

GATTINO



Adoperate 2 fogli uguali quadrati bicolori, 1 per la costruzione della testa ed 1 per la costruzione del corpo, che si uniscono mediante un idoneo bloccaggio.

COSTRUZIONE DELLA TESTA

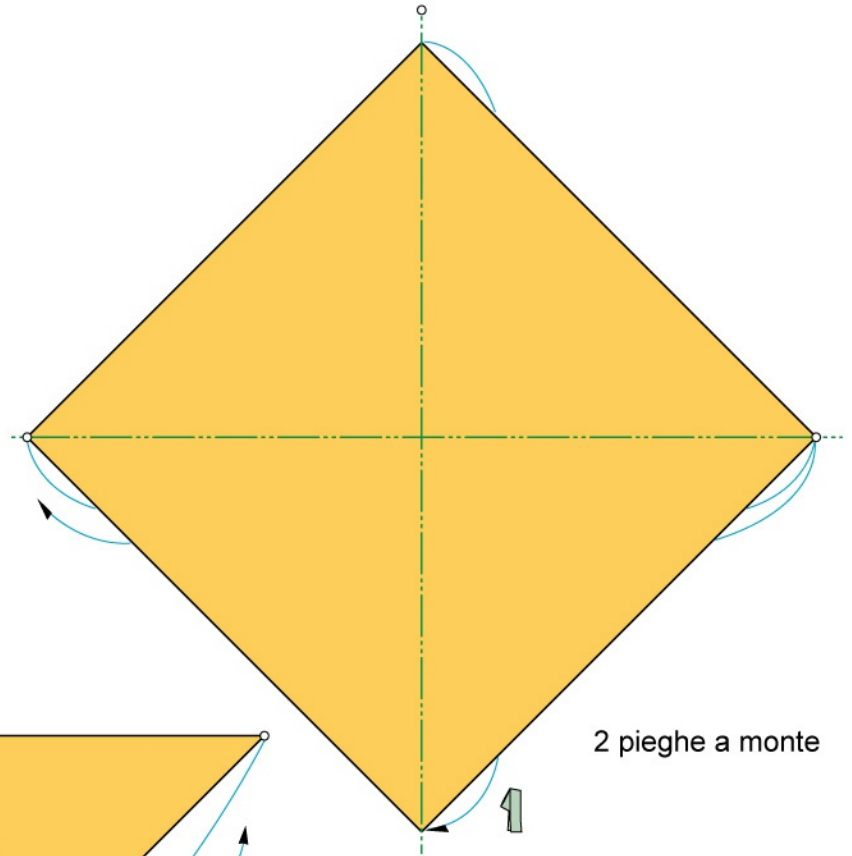

2 pieghe a monte

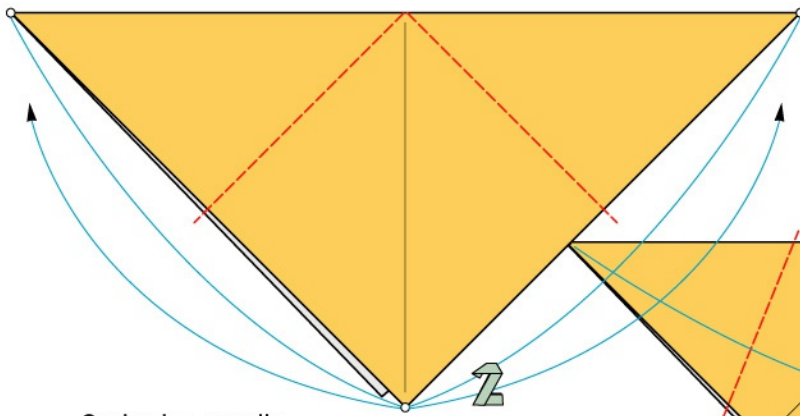

2 pieghe a valle

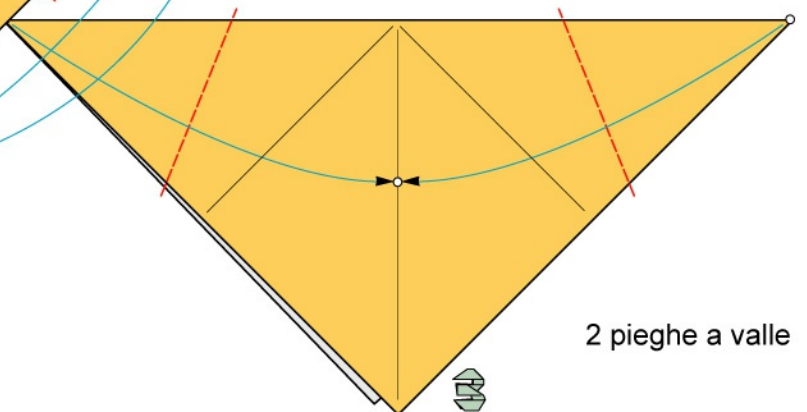

2 pieghe a valle

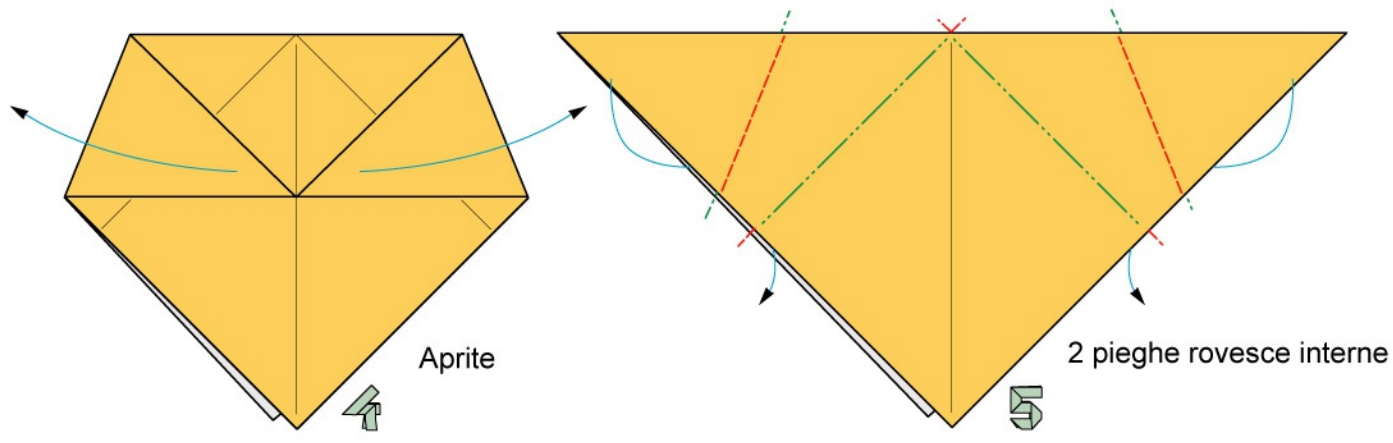

Aprite

2 pieghe rovesce interne

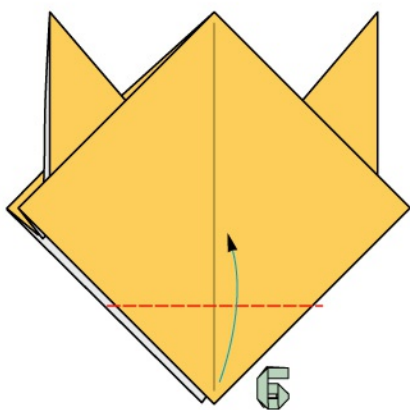

1 piega a valle

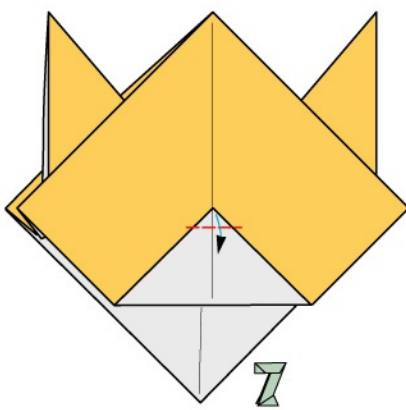

1 piega a valle

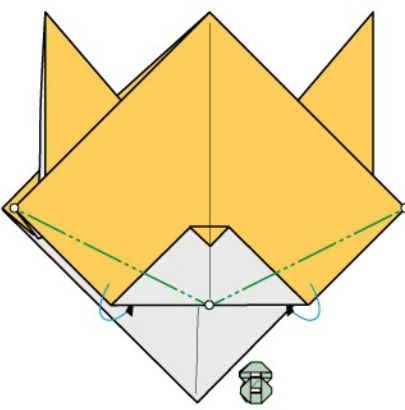

2 pieghe a monte

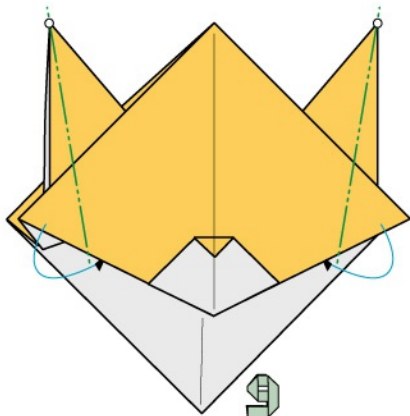

2 pieghe a monte

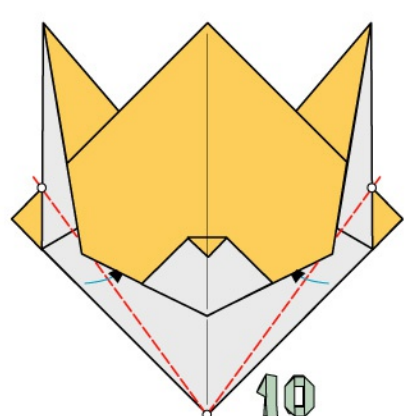

2 pieghe a valle

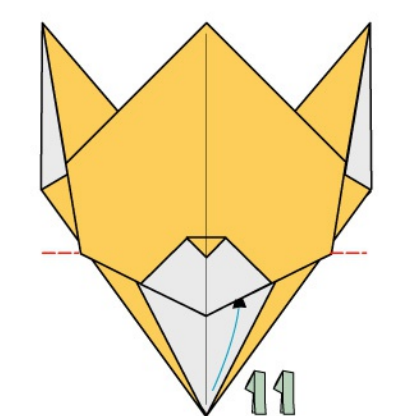

1 piega a valle ed intascate

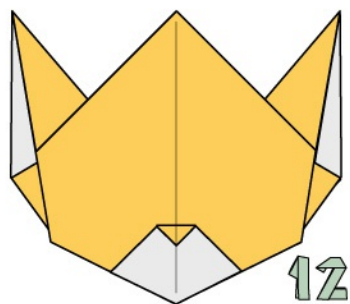

Testa ultimata



Foto di tasca in cui si deve inserire il corpo

COSTRUZIONE DEL CORPO

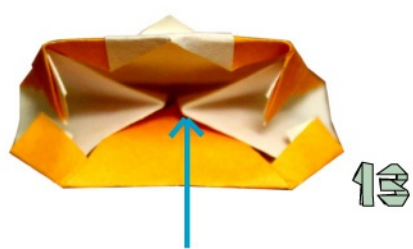
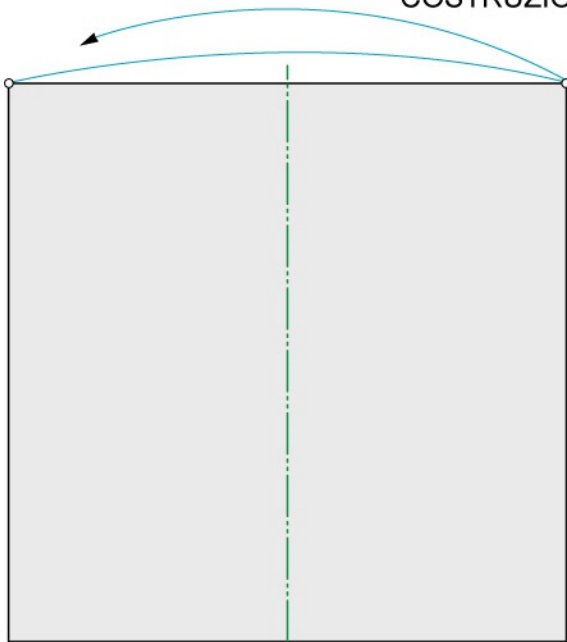

1

1 piega a monte

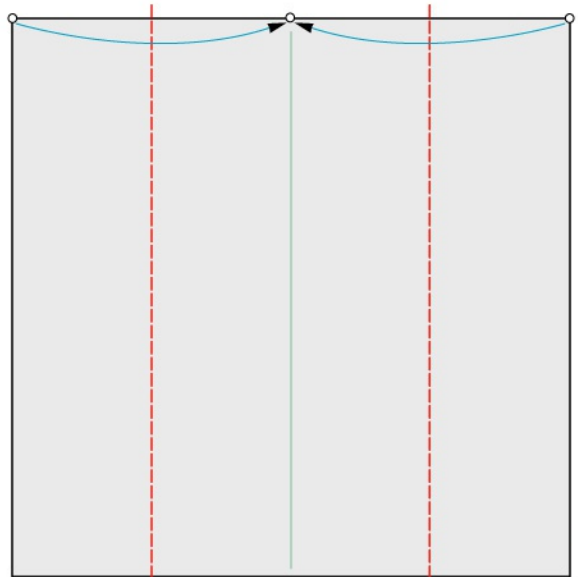

2

2 pieghe a valle

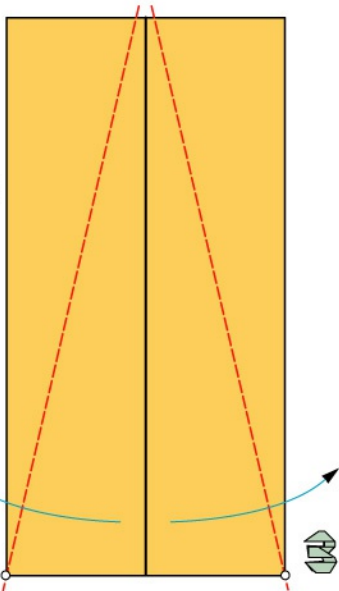

2 pieghe a valle

3

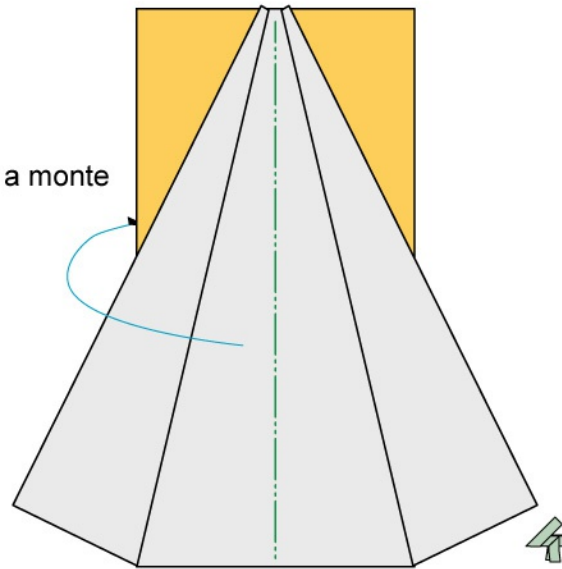

Ripiegate a monte

4

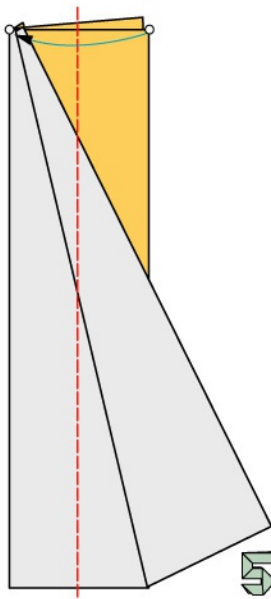

5

1 piega a valle

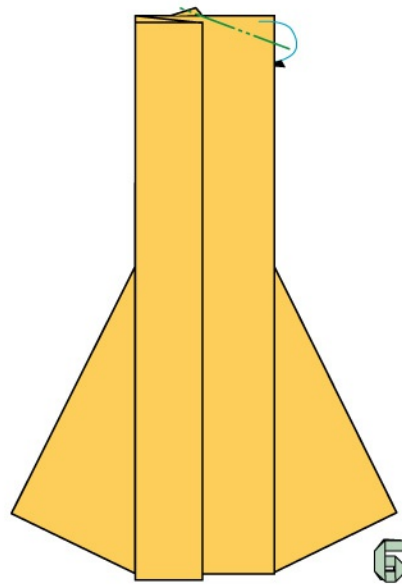

6

1 piega a monte

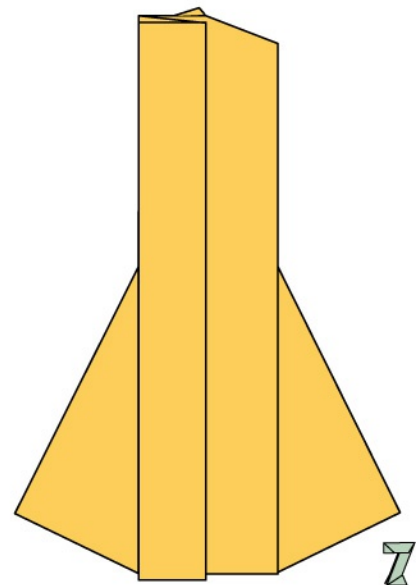

7

Corpo ultimato

UNIONE DELLA TESTA CON IL CORPO

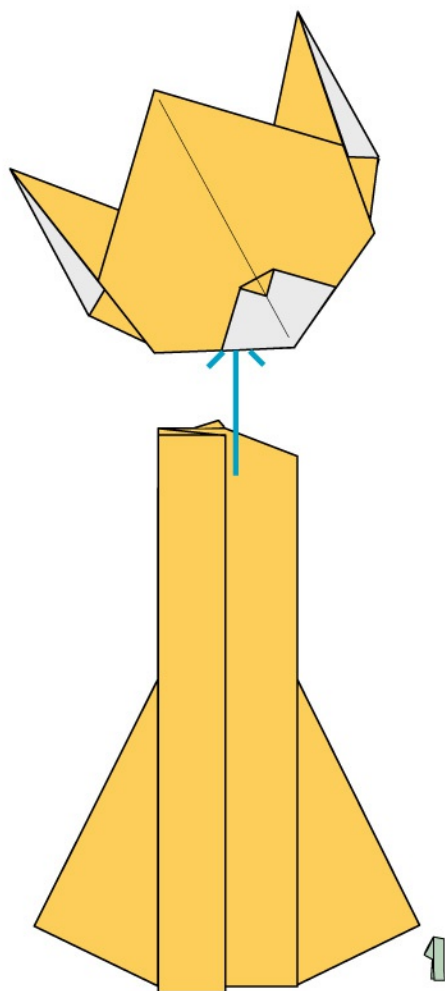

Inserite il corpo nella tasca della testa

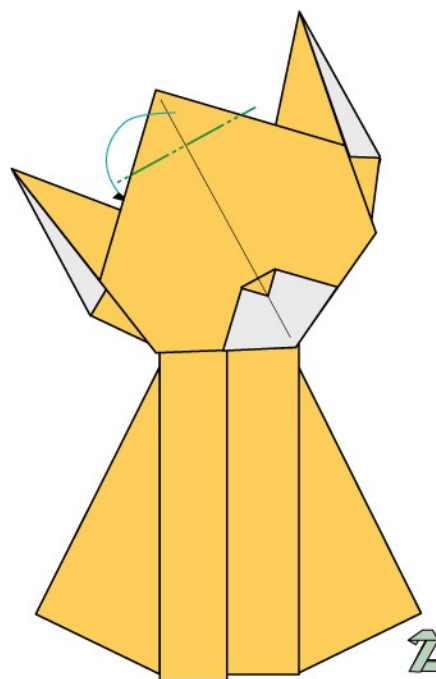

Con una piega a monte bloccate l'unione

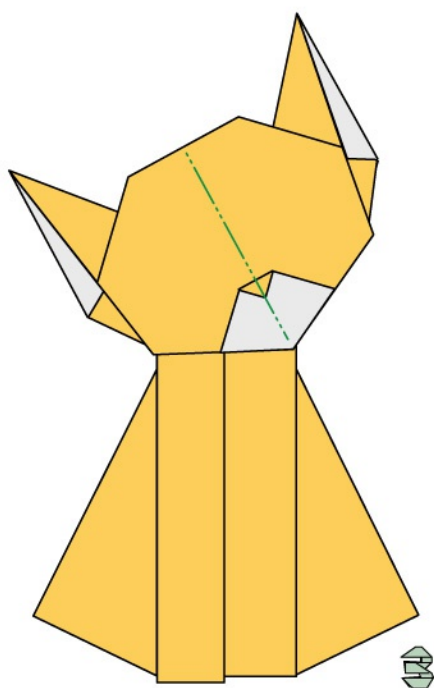

Ripiegate a monte

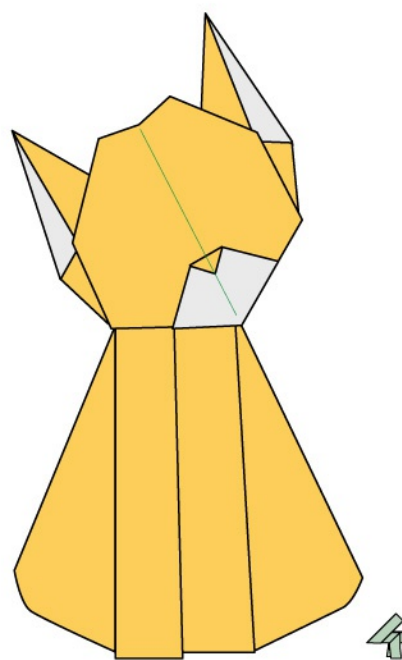

Gattino ultimato



ORSETTO



Adoperate 2 fogli uguali quadrati bicolori, 1 per la costruzione della testa ed 1 per la costruzione del corpo, che si uniscono mediante un idoneo bloccaggio.

COSTRUZIONE DELLA TESTA

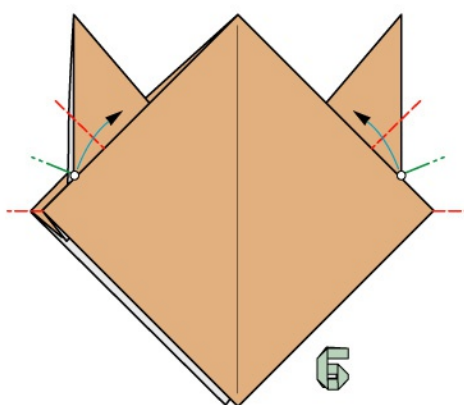

Partite dalla fig. n. 5 del "gattino"

6

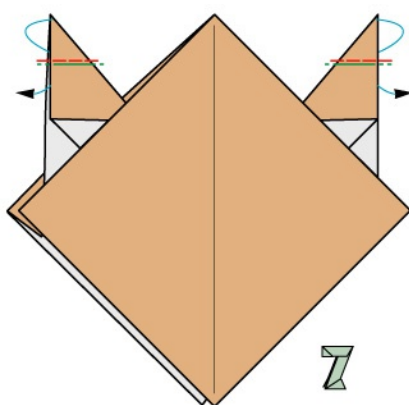

2 pieghe rovesce interne

7

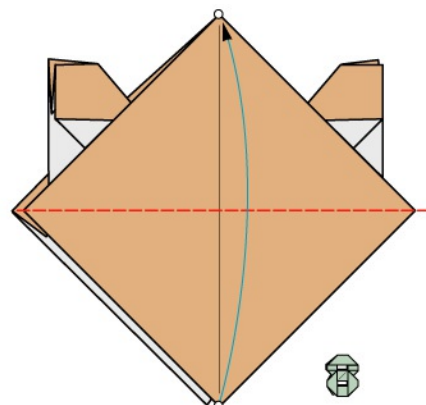

1 piega a valle

8

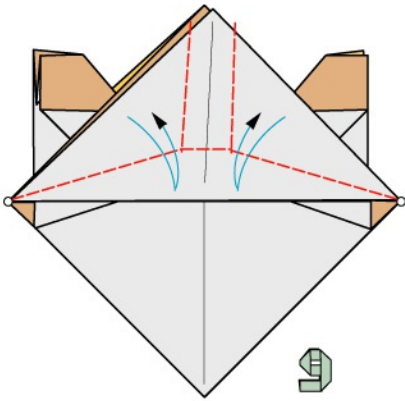

5 pieghe a valle

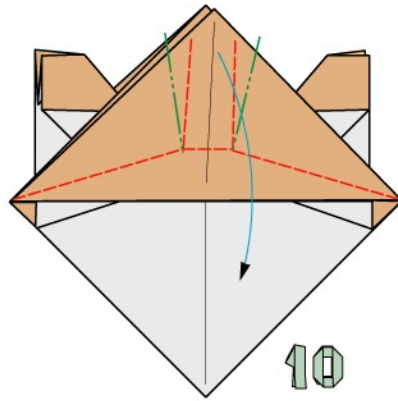

2 pieghe a monte e
ripiegate a valle

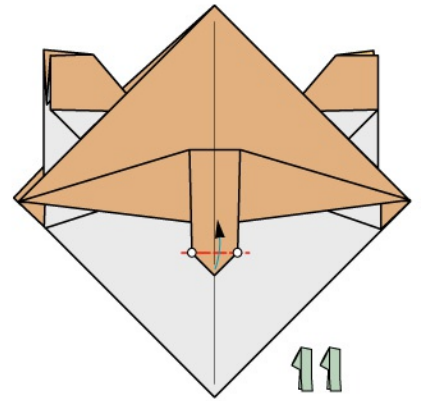

1 piega a valle

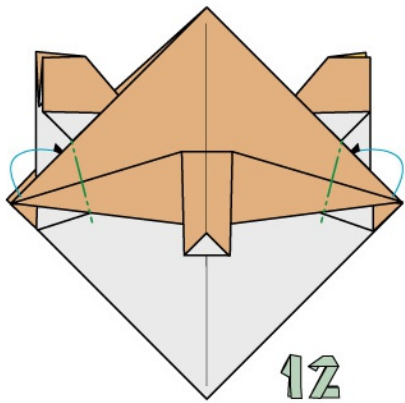

2 pieghe a monte

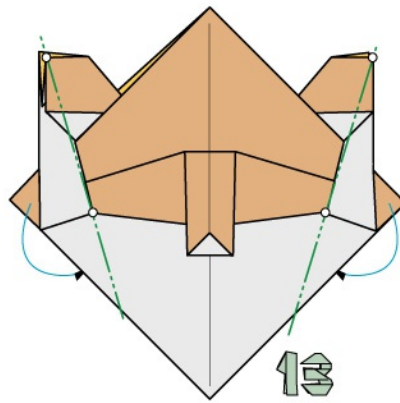

2 pieghe a monte

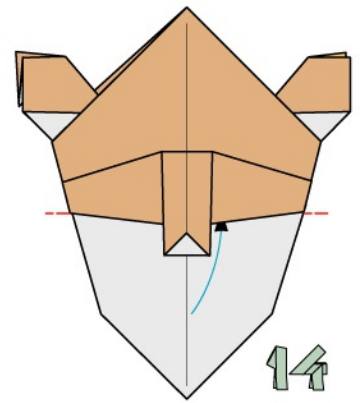

1 piega a valle
ed intascate

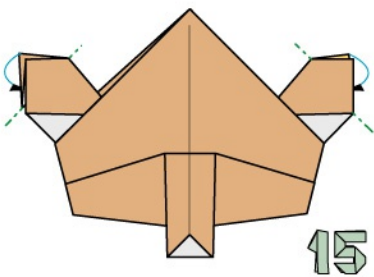

2 pieghe a monte

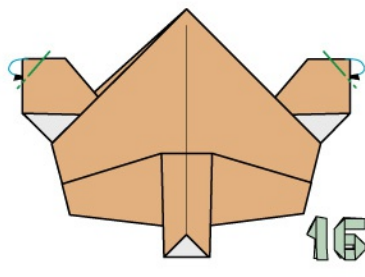

2 pieghe a monte

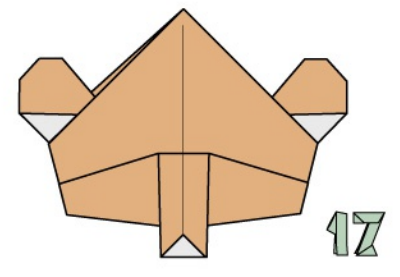

Testa ultimata

COSTRUZIONE DEL CORPO

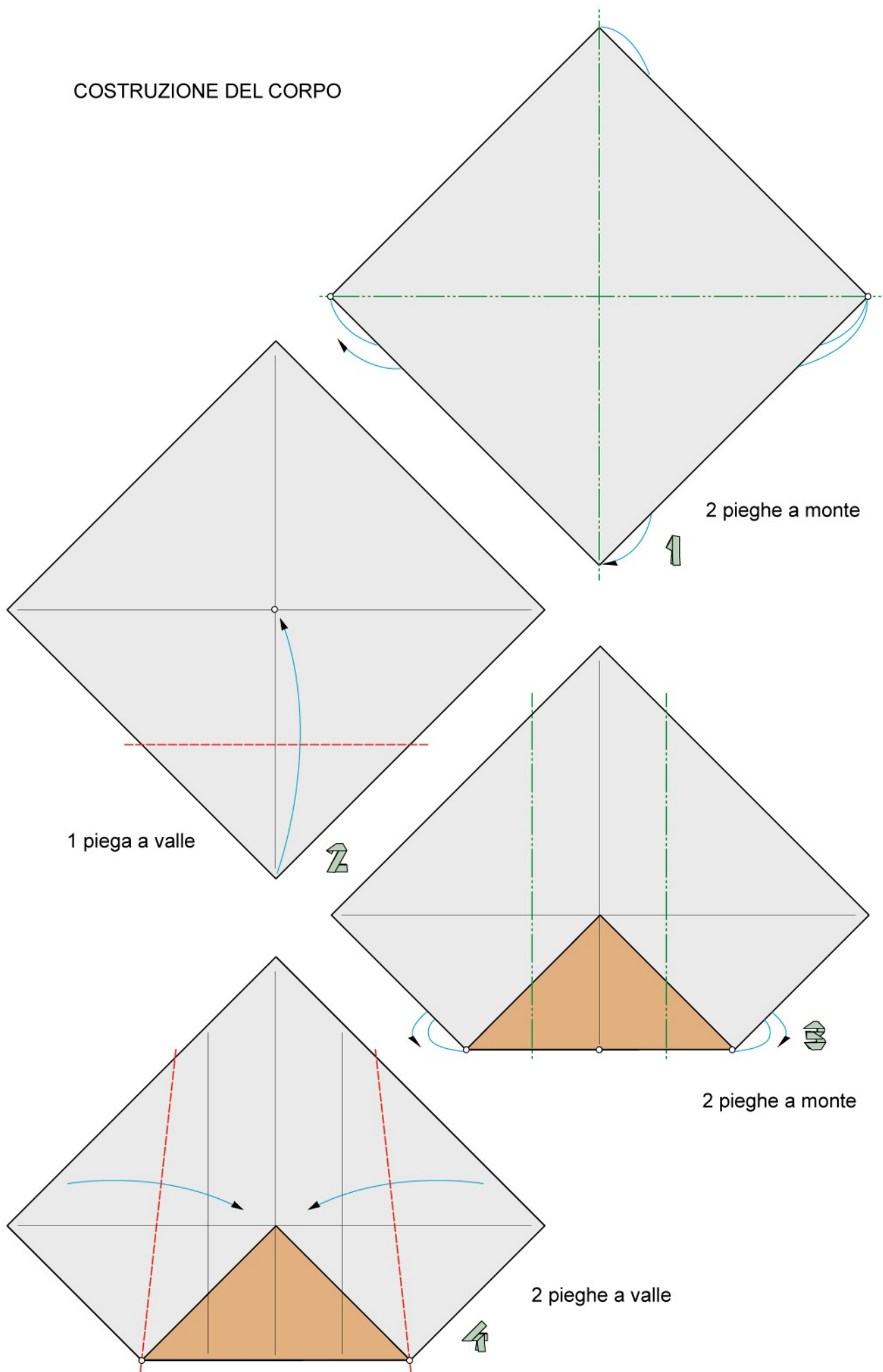

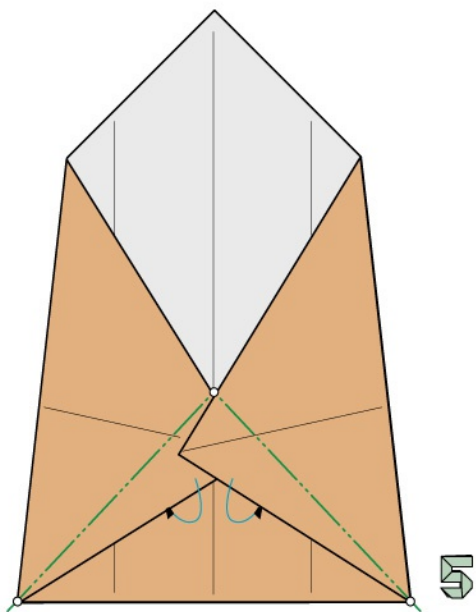

2 pieghe a monte

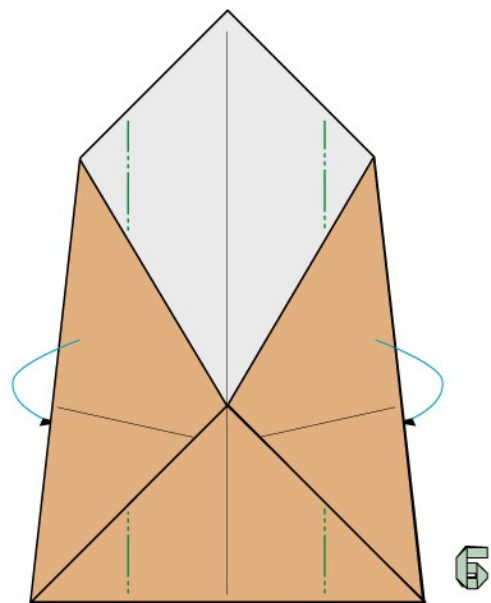

Ripiegate a monte

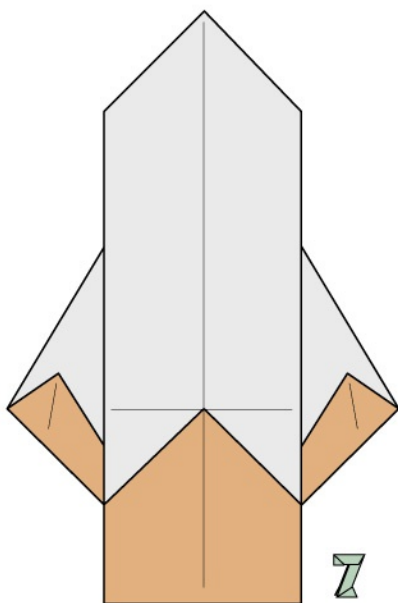

Ribaltate

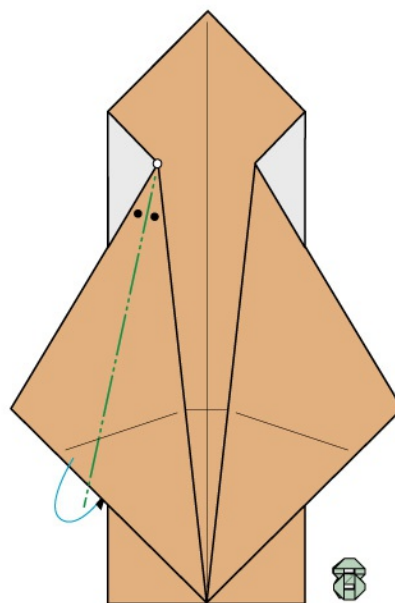

1 piega bisettrice a monte

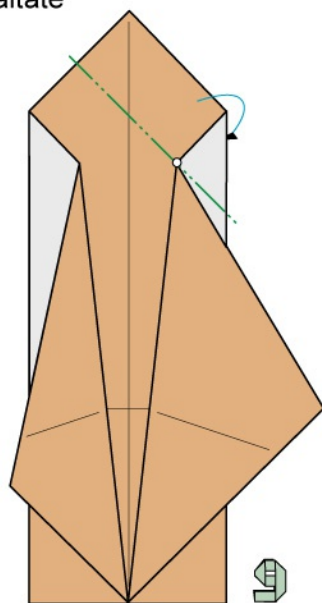

1 piega a monte

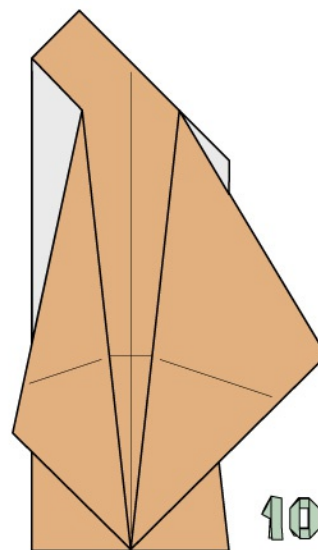

Corpo ultimato

UNIONE DELLA TESTA CON IL CORPO

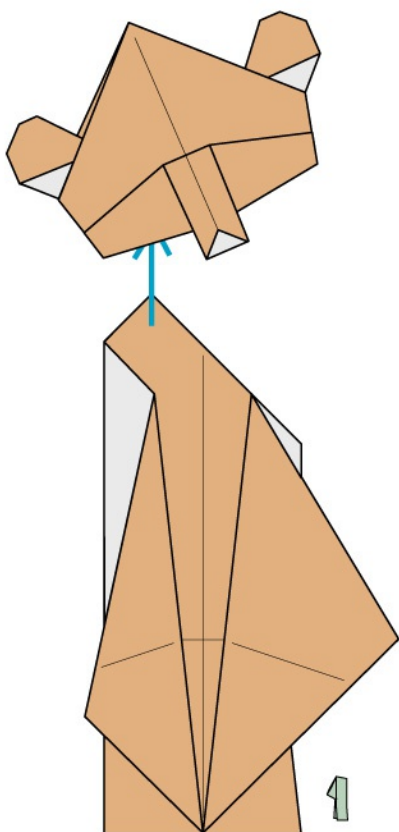

Inserite il corpo nella tasca della testa

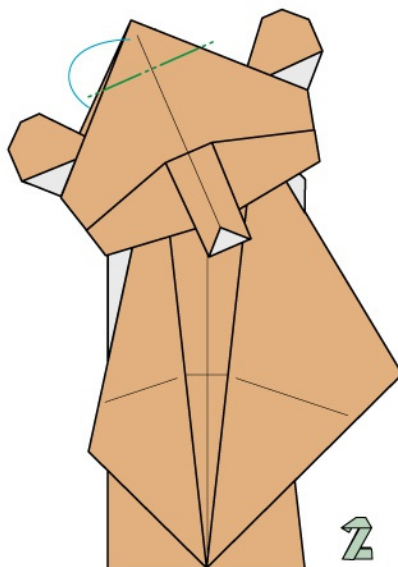

Con una piega a monte bloccate l'unione

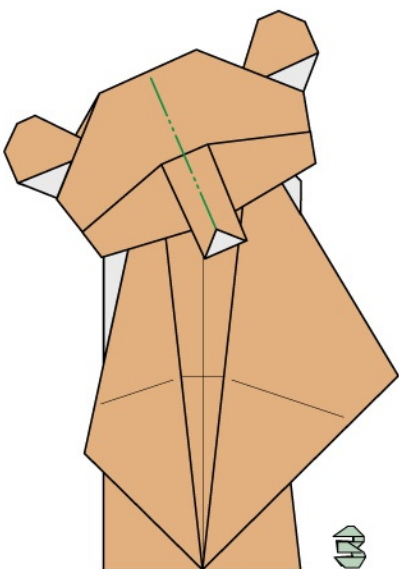

Ripiegate a monte

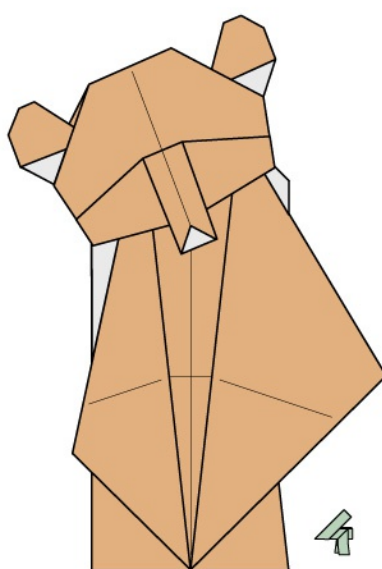

Orsetto ultimato

TOPOLINO



Adoperate 2 fogli uguali quadrati bicolori, 1 per la costruzione della testa ed 1 per la costruzione del corpo, che si uniscono mediante un idoneo bloccaggio.

COSTRUZIONE DELLA TESTA

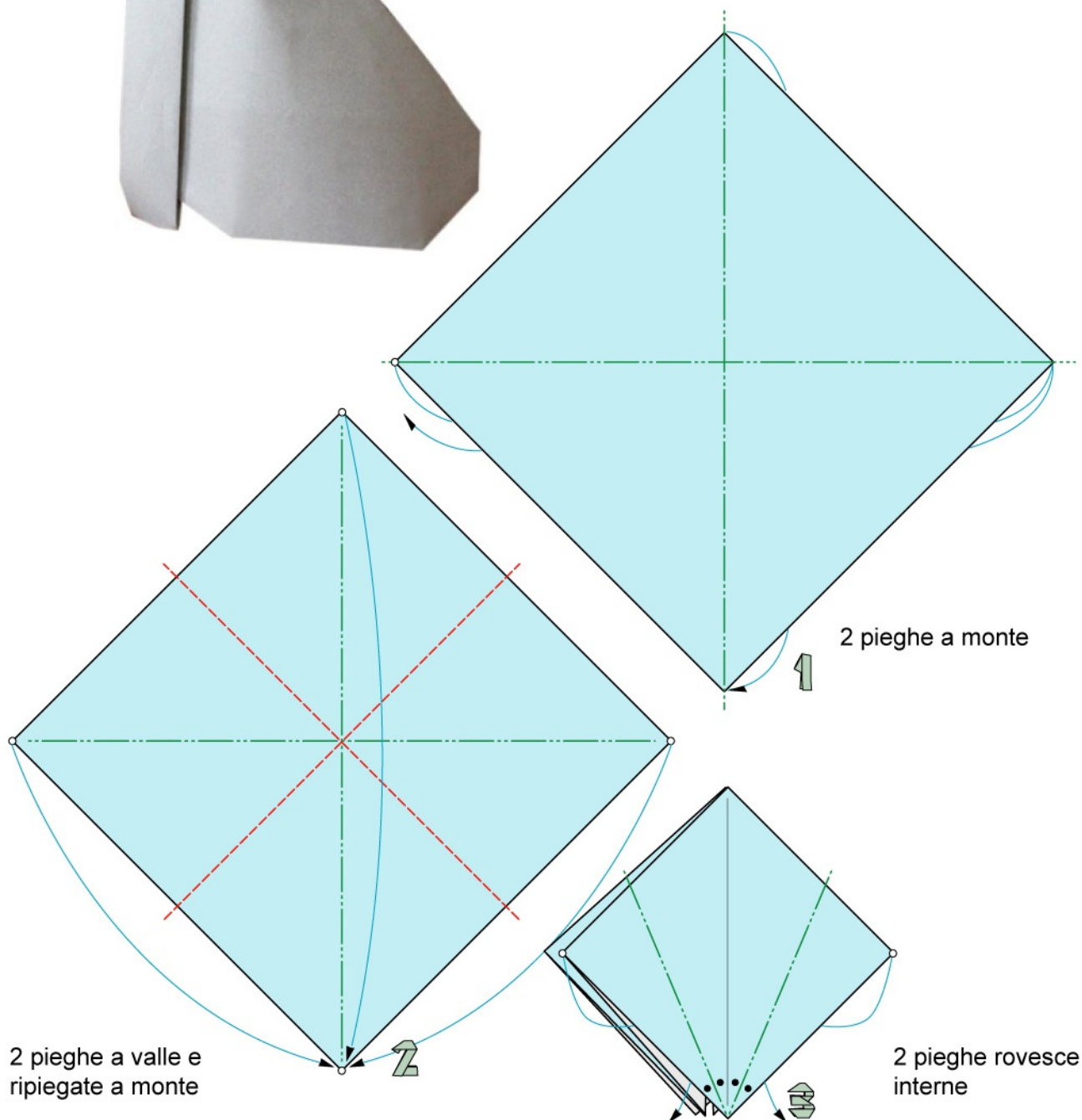

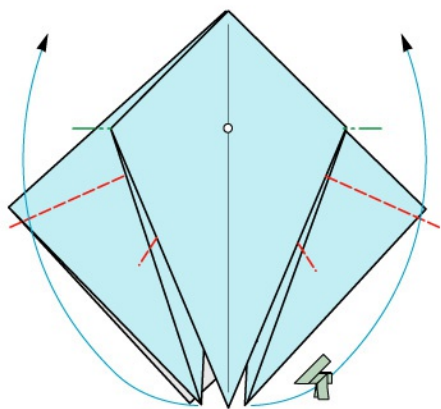

4 pieghe a valle, 2 a monte e piegate rovesciando

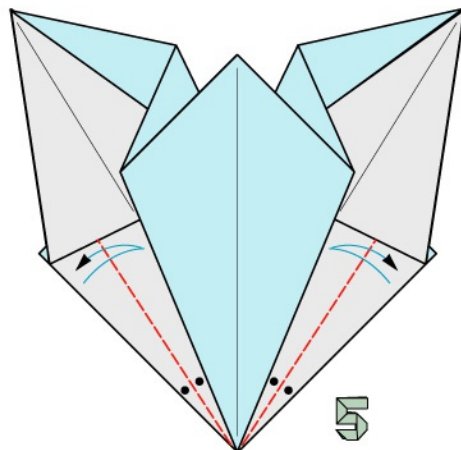

2 pieghe a valle

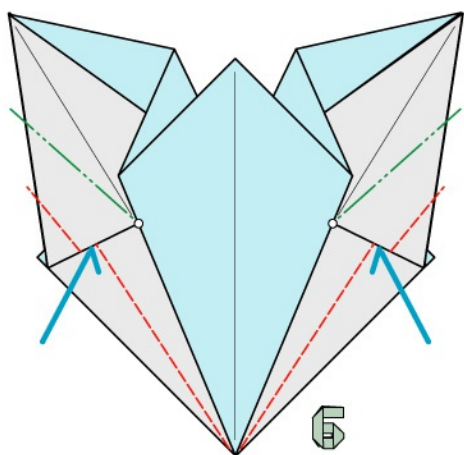

4 pieghe a valle, 2 a monte e fate rientrare le superfici indicate

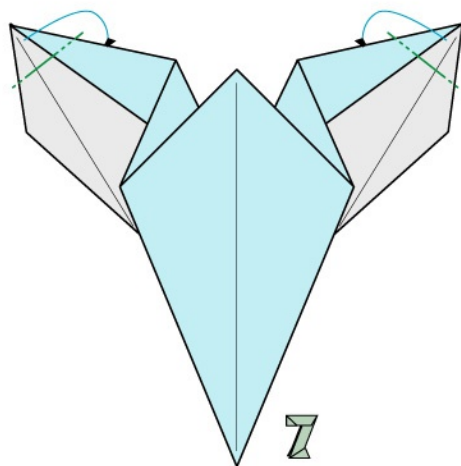

2 pieghe a monte

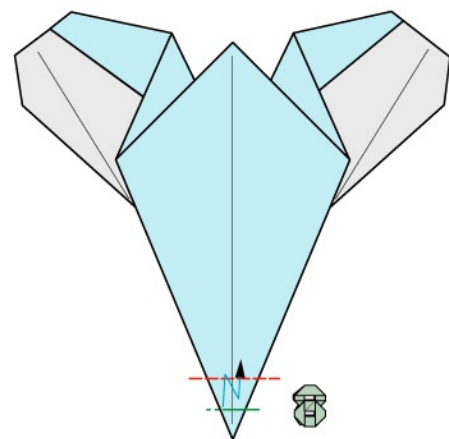

1 piega a valle ed 1 a monte

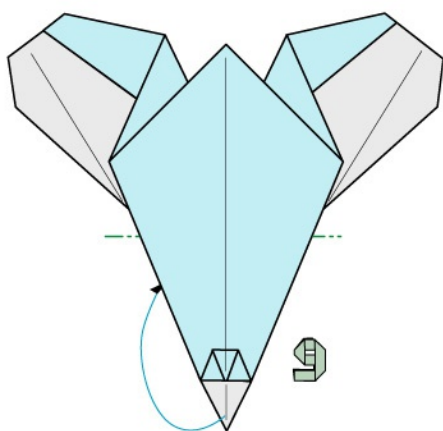

1 piega a monte sottostante

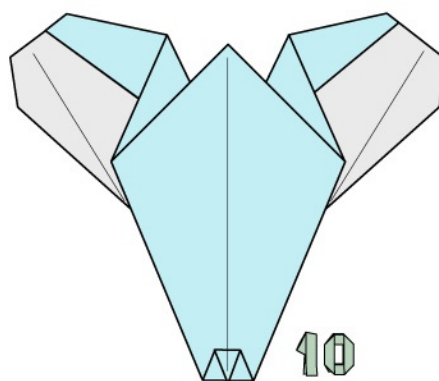

Testa del topolino ultimata

COSTRUZIONE DEL CORPO

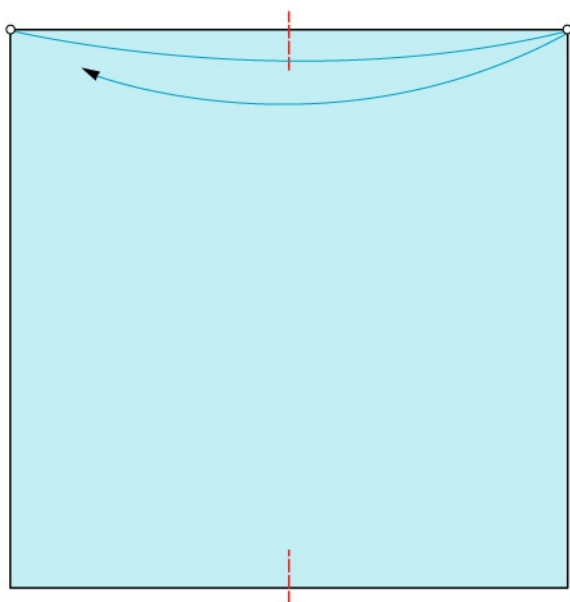

2 piccole pieghe a valle

1

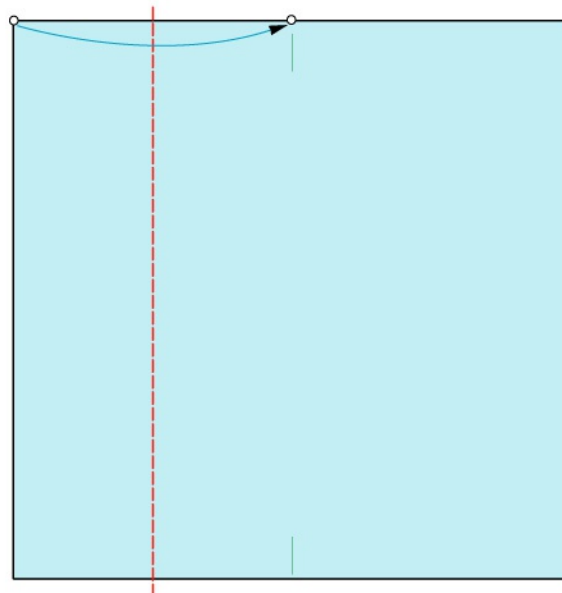

1 piega a valle

2

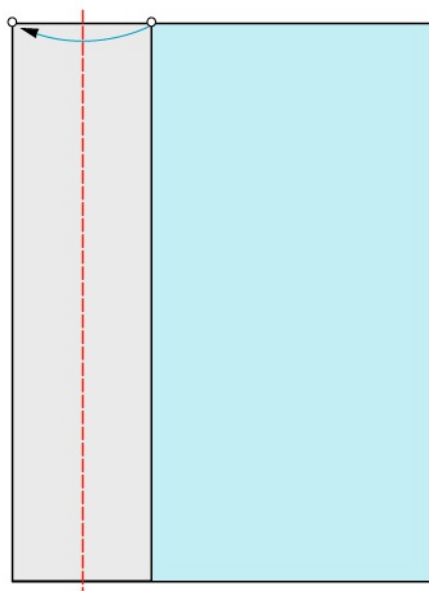

1 piega a valle

3

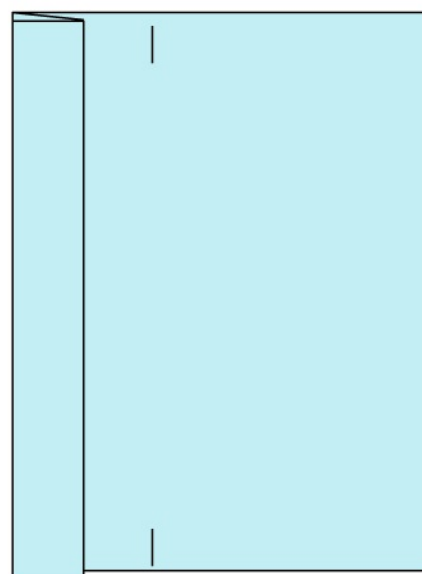

Ribaltate

4



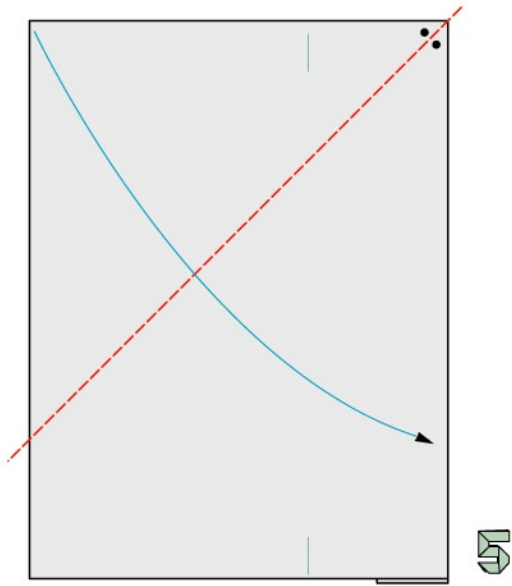

1 piega bisettrice a valle

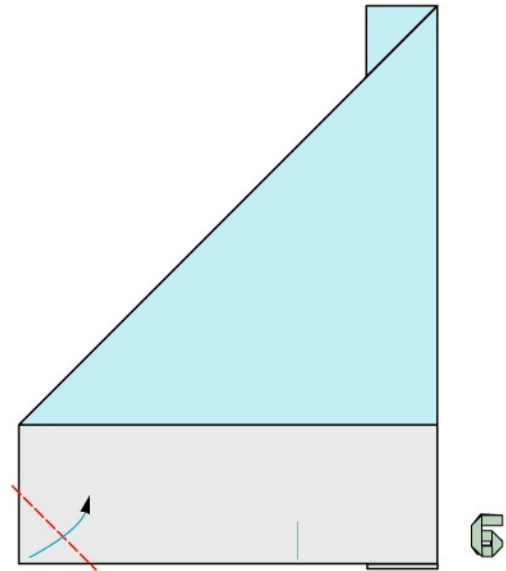

1 piega a valle

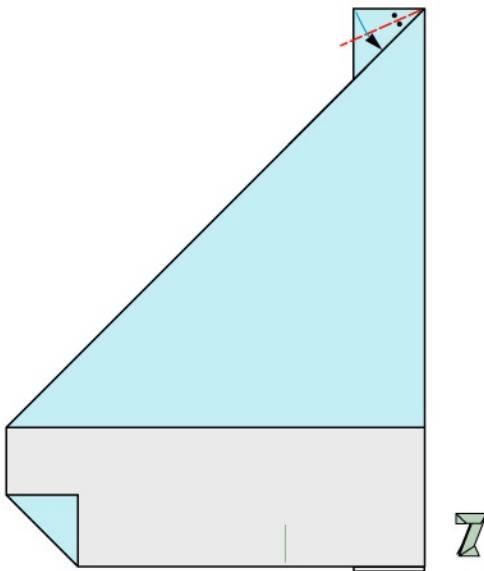

1 piega bisettrice a valle

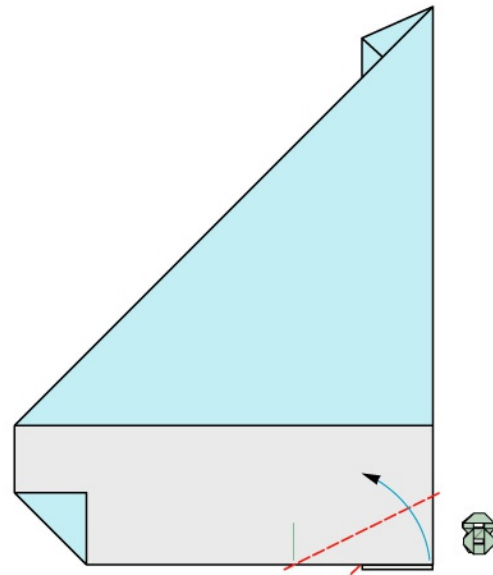

1 piega a valle

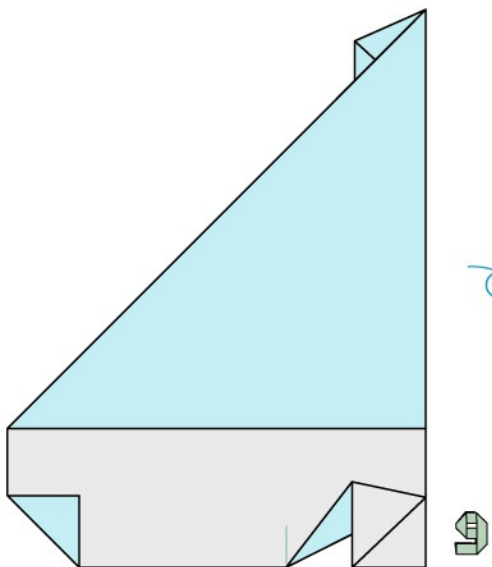

Ribaltate

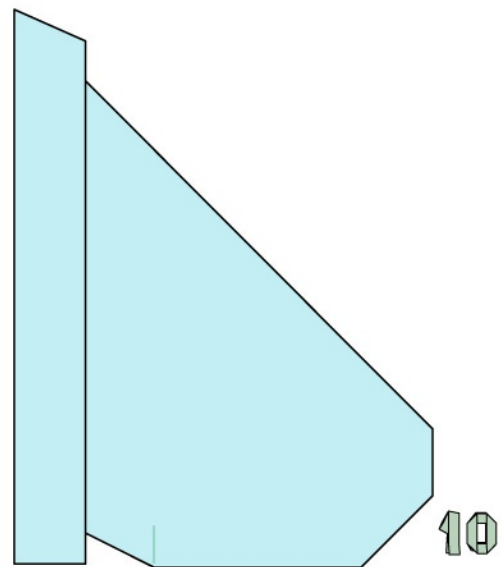

Corpo ultimato

UNIONE DELLA TESTA CON IL CORPO

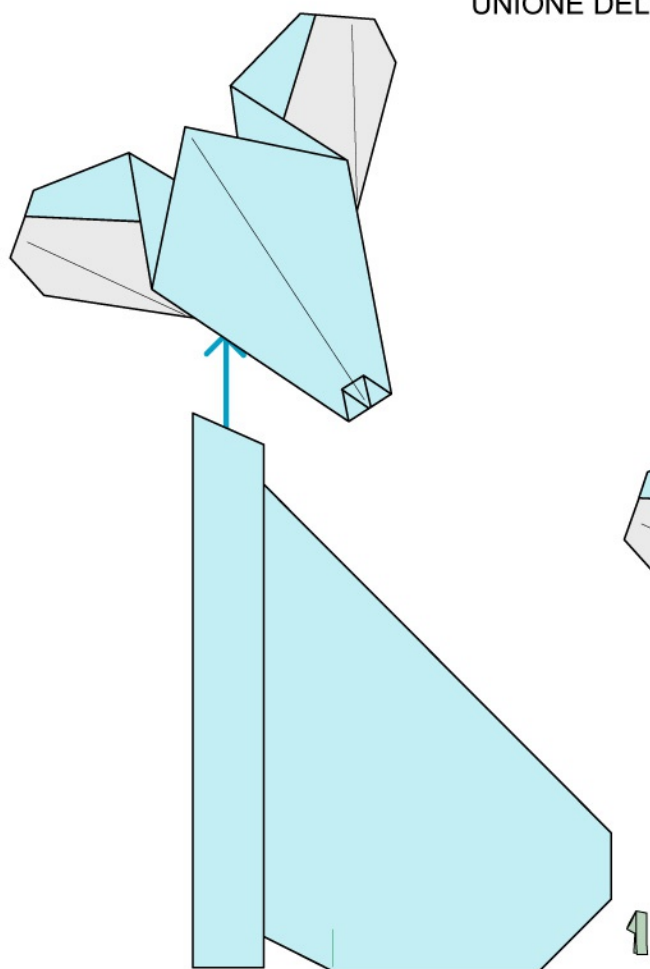

Inserite il corpo nella tasca della testa

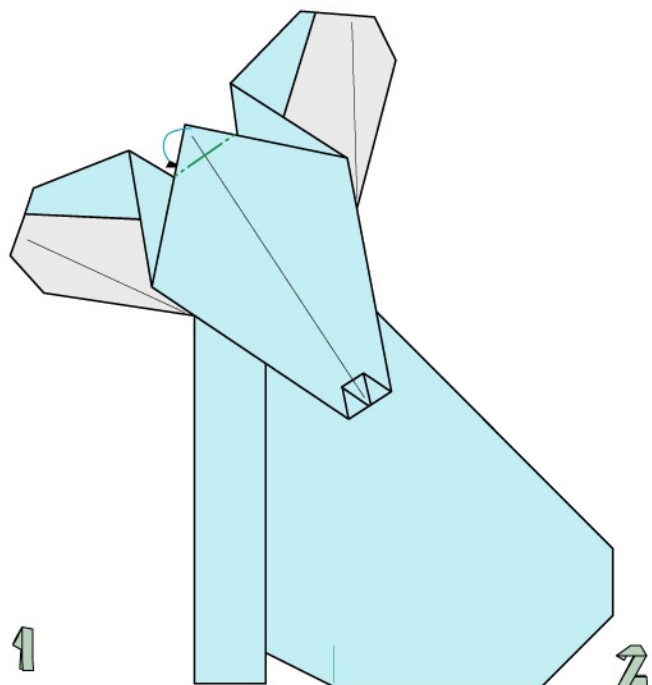

Con una piega a monte bloccate l'unione

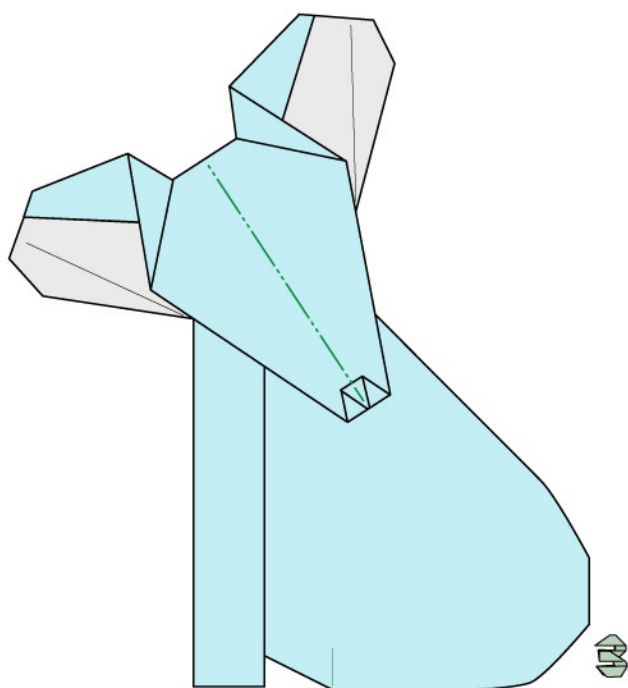

Ripiegate a monte

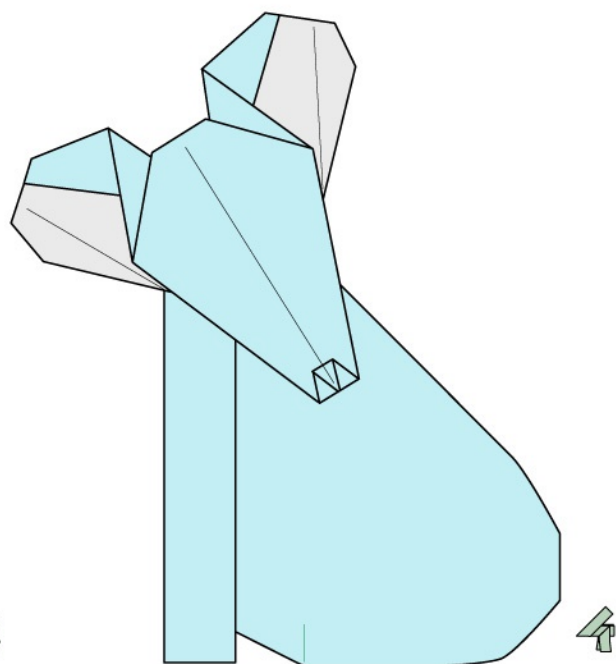

Topolino ultimato

VOLPINA

Adoperate 2 fogli uguali quadrati bicolori, 1 per la costruzione della testa ed 1 per la costruzione del corpo, che si uniscono mediante un idoneo bloccaggio.

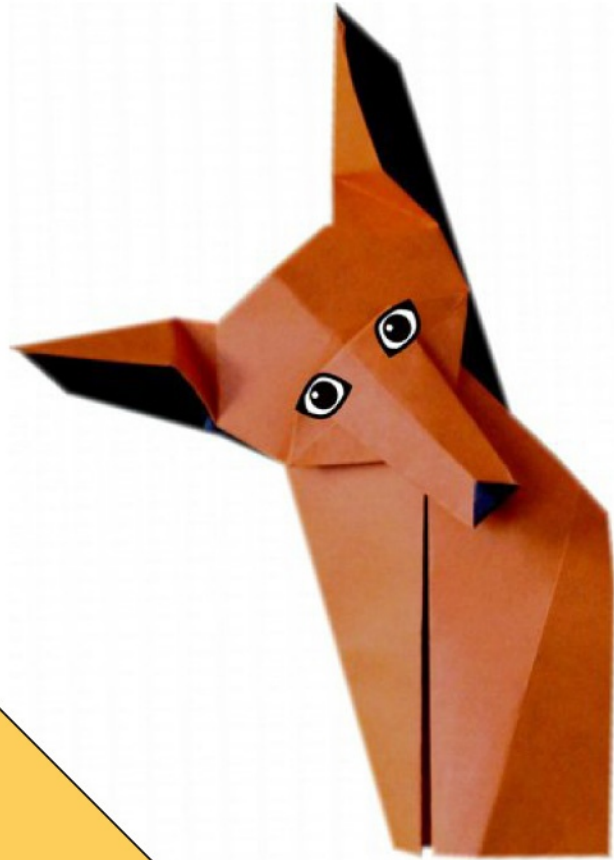

COSTRUZIONE DELLA TESTA

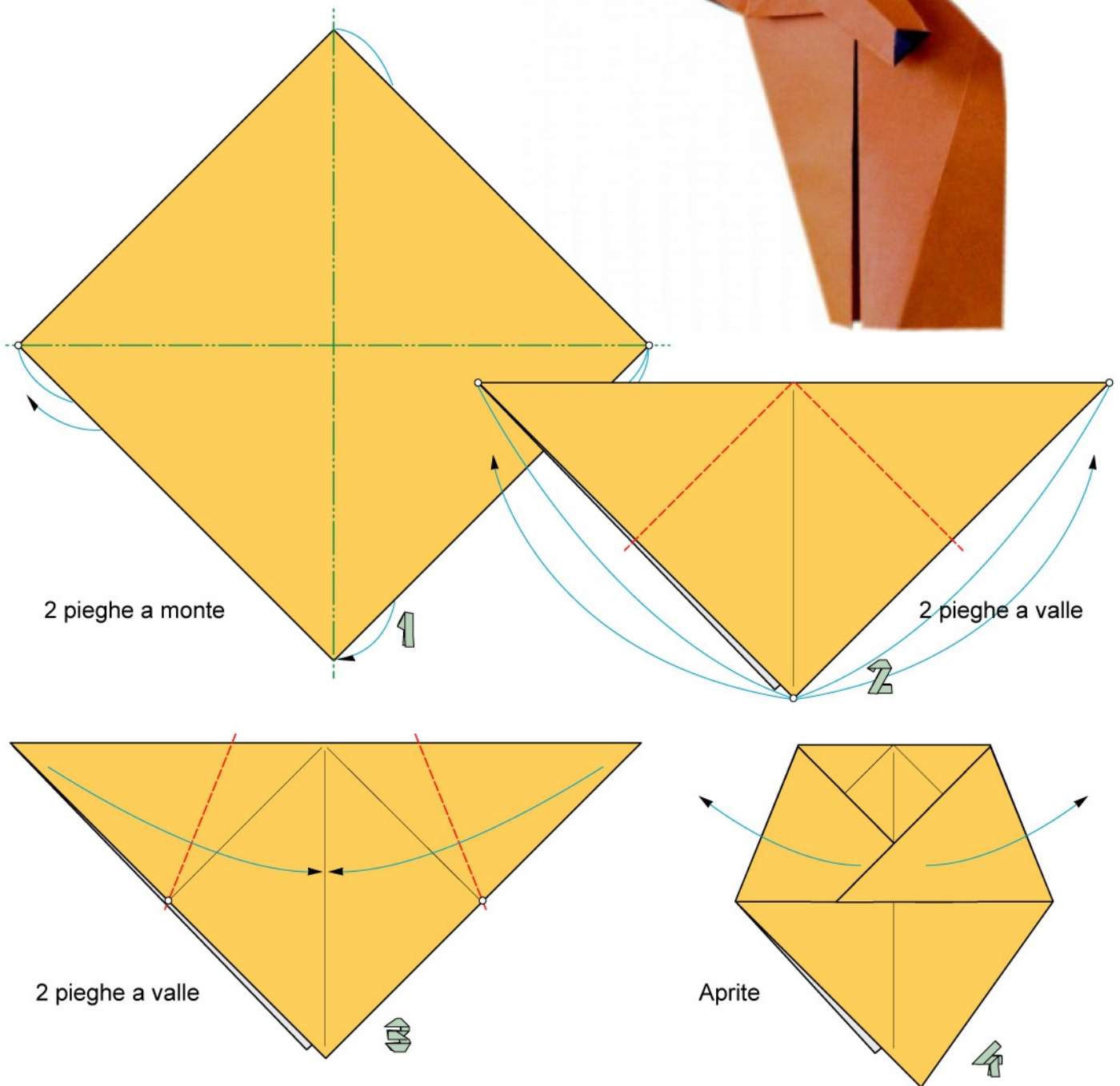

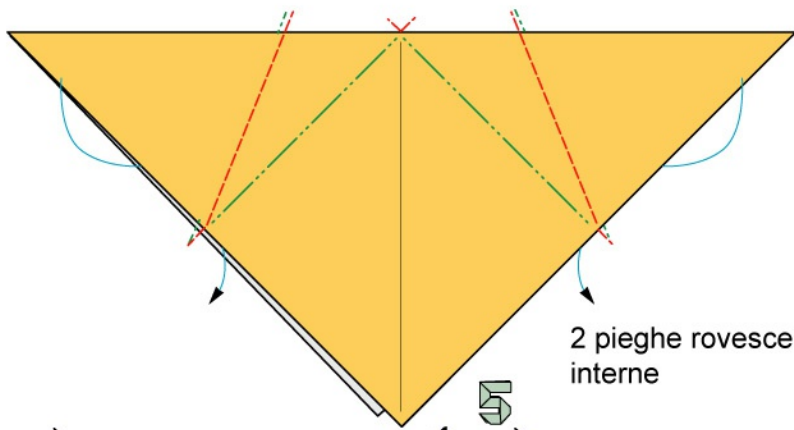

2 pieghe rovesce interne

5

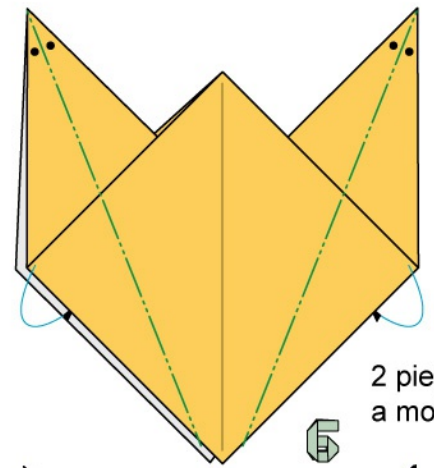

2 pieghe a monte

6

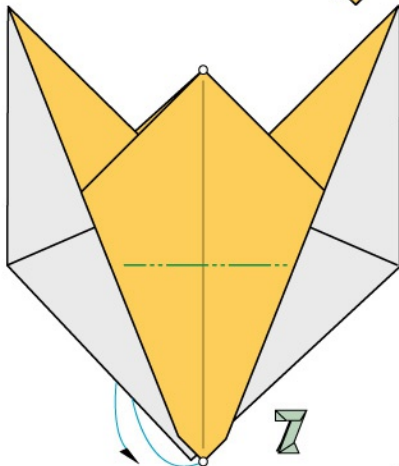

1 piega a monte

7

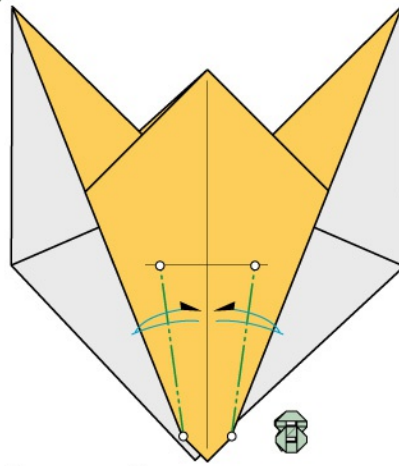

2 pieghe a monte

8

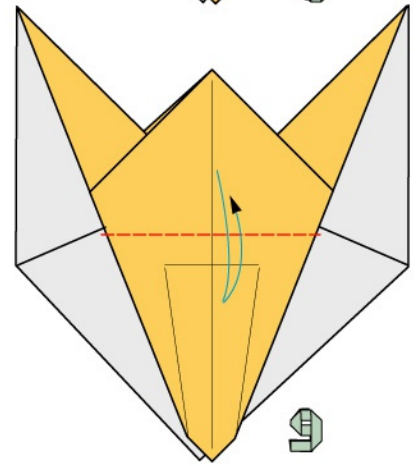

1 piega a valle

9

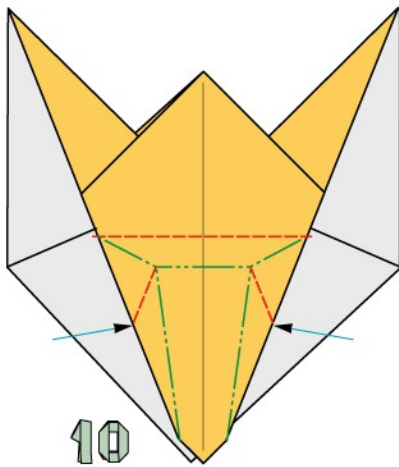

10

2 nuove pieghe a valle ed a monte e ripiegando, fate rientrare le superfici

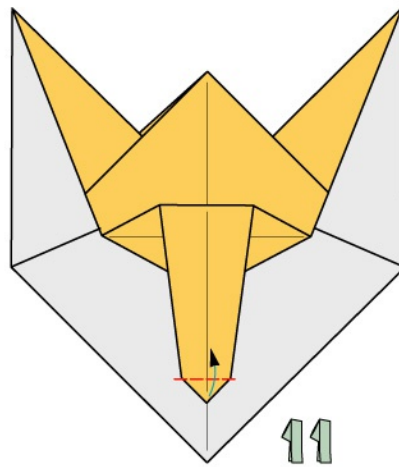

11

1 piega a valle

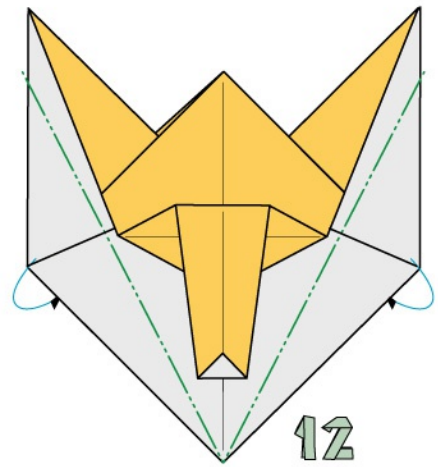

12

2 pieghe a monte

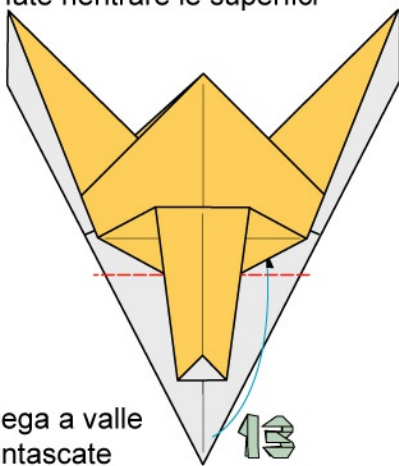

13

1 piega a valle ed intascate

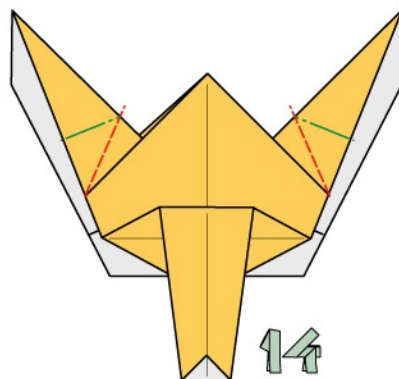

14

2 pieghe a valle e 2 a monte per aprire le orecchie

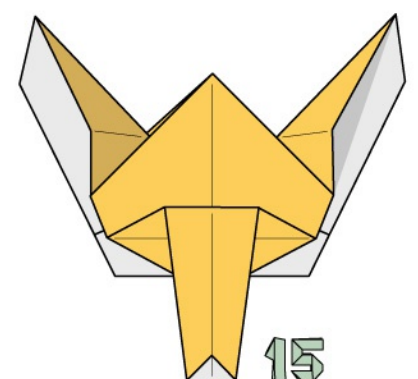

15

Testa ultimata

COSTRUZIONE DEL CORPO

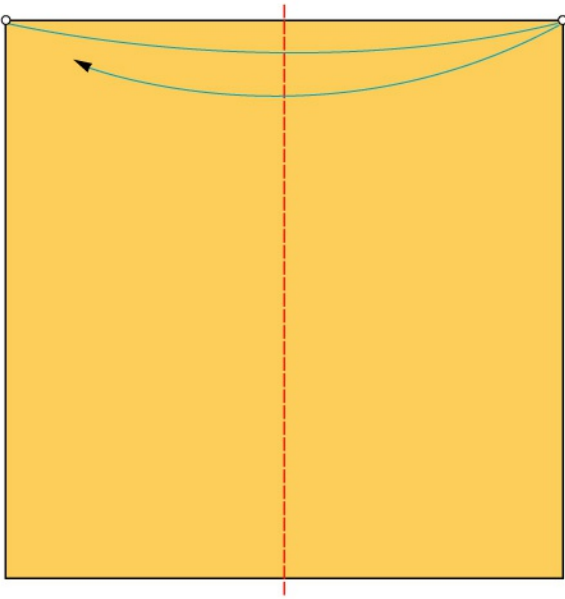

1 piega a valle

1

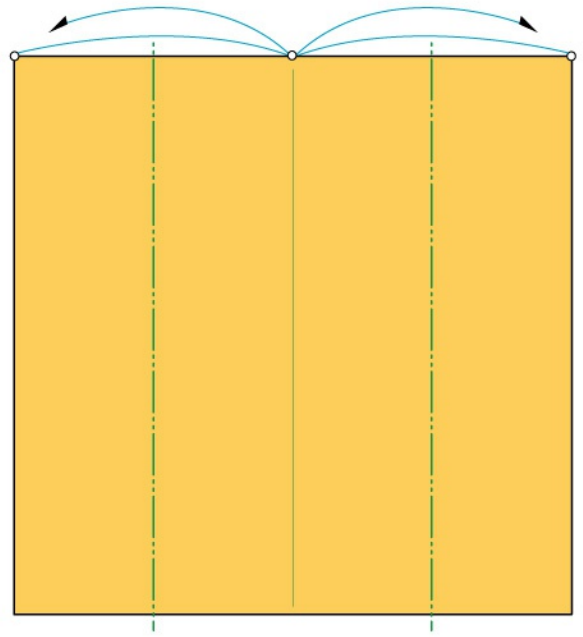

2 pieghe a monte

2

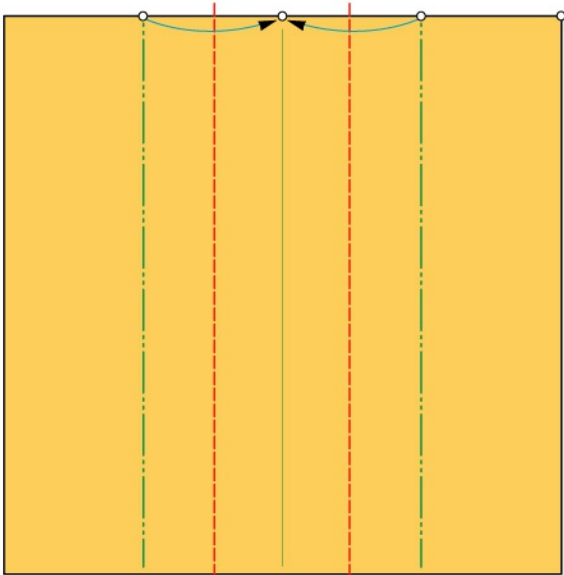

2 pieghe a valle e ripiegate a monte

3

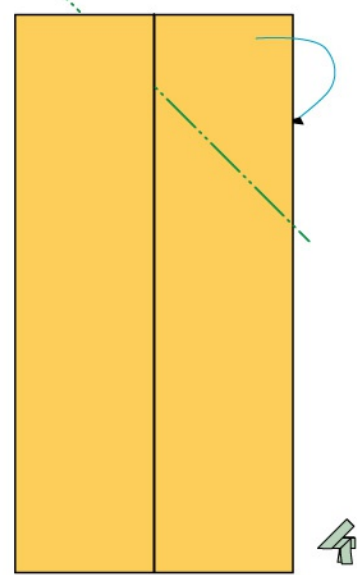

1 piega a monte

4

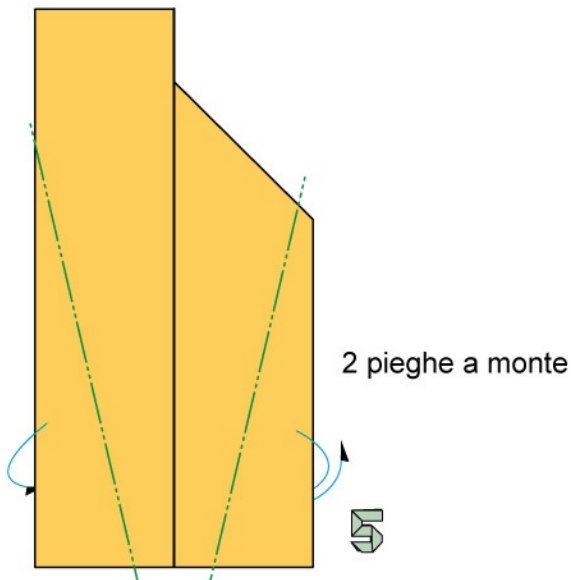

2 pieghe a monte

5

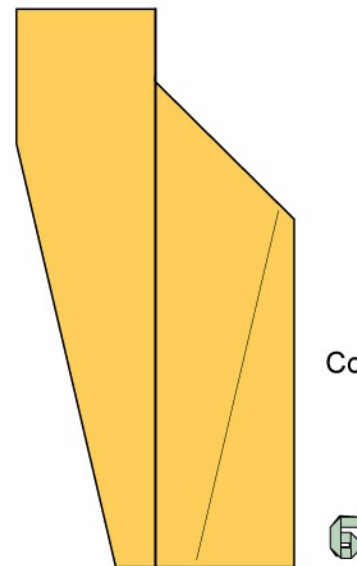

Corpo ultimato

6

UNIONE DELLA TESTA CON IL CORPO

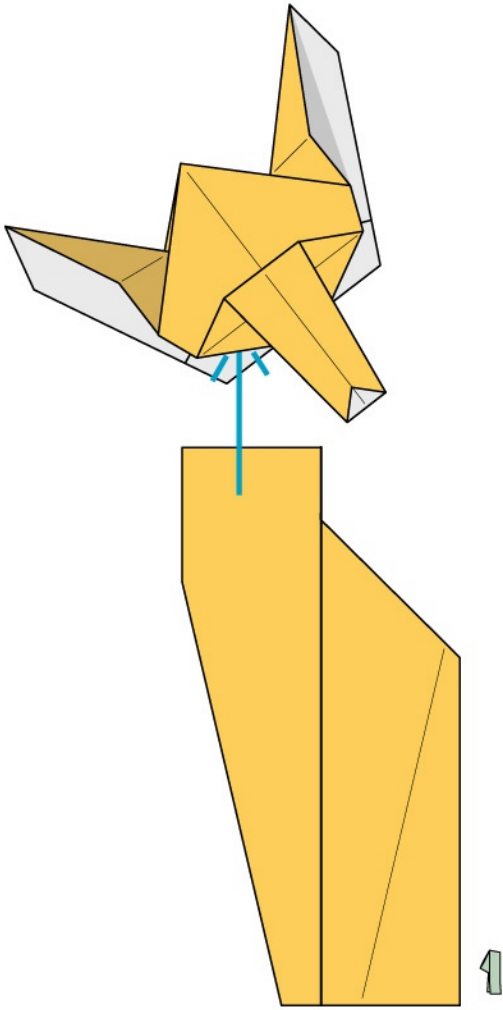

Inserite il corpo nella tasca della testa

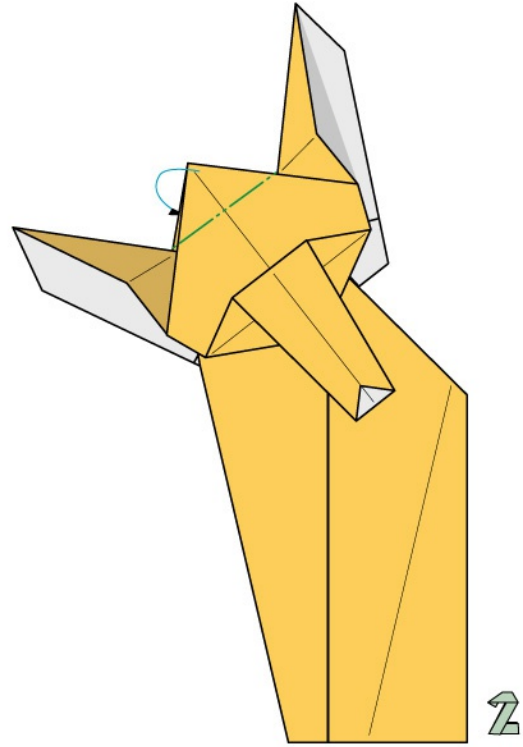

Con una piega a monte bloccate l'unione

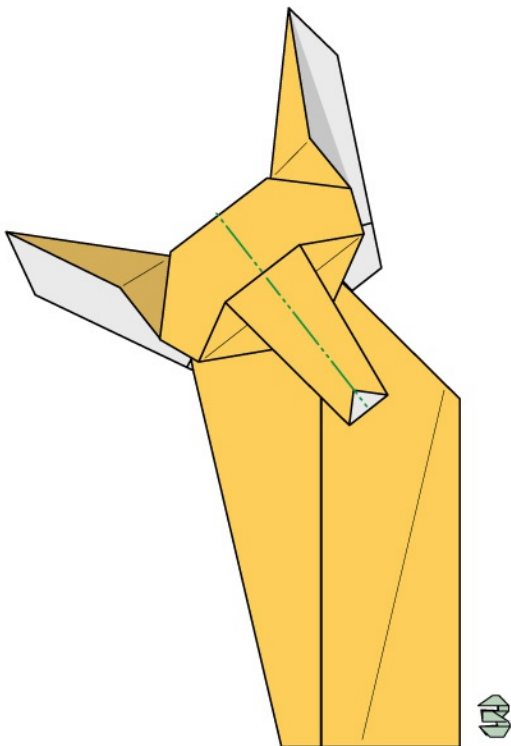

Ripiegate a monte

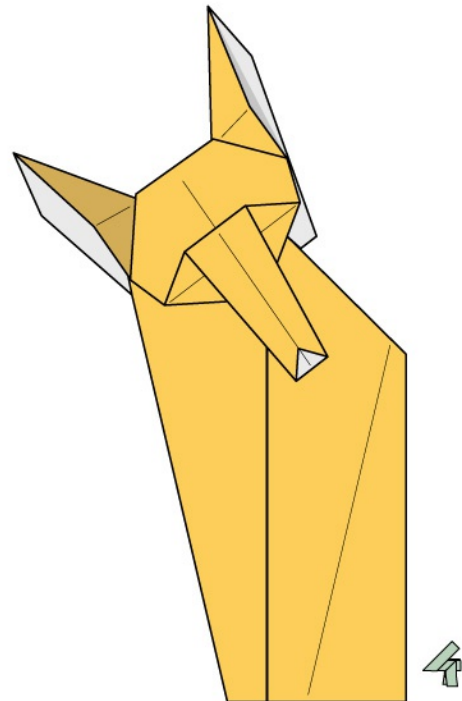

Volpina ultimata

MAIALINO



Adoperate 2 fogli uguali quadrati monocolori o bicolori, 1 per la costruzione della testa ed 1 per la costruzione del corpo, che si uniscono mediante un idoneo bloccaggio.

COSTRUZIONE DELLA TESTA

Partite dalla fig.n. 7 della "volpina"

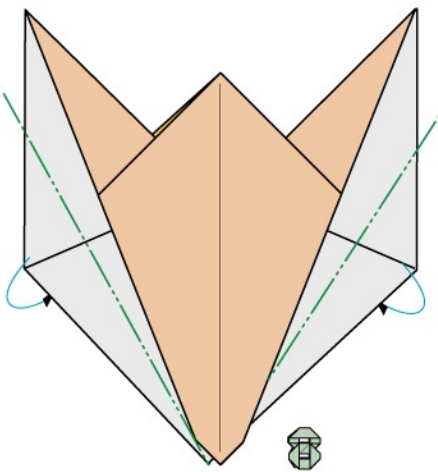

2 pieghe a monte

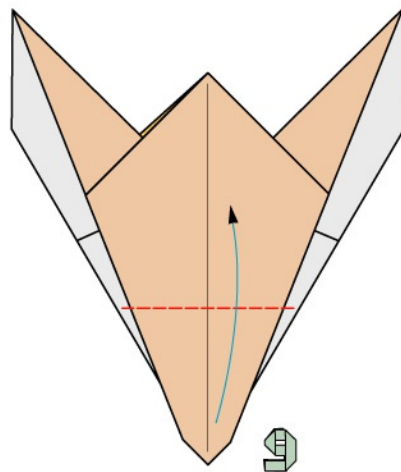

1 piega a valle

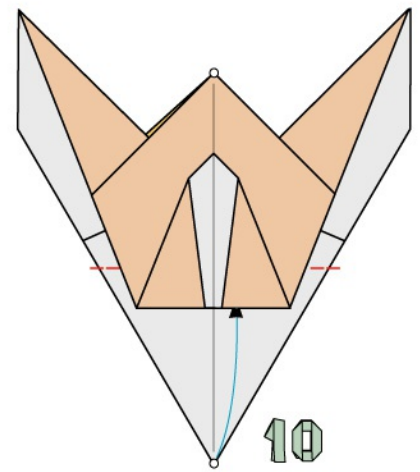

1 piega a valle e intascate

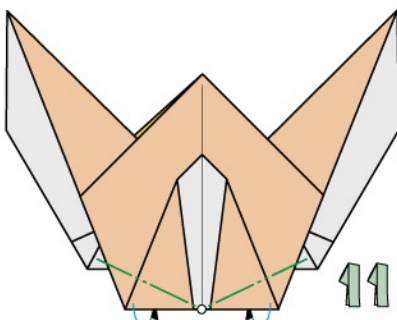

2 pieghe a monte

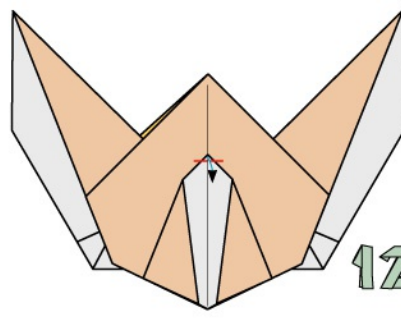

1 piccola piega a valle

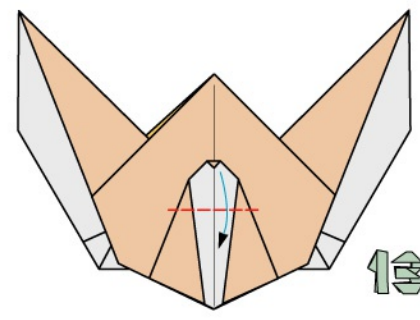

1 piega a valle

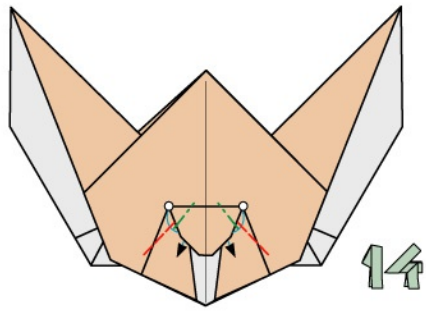

2 pieghe rovesce interne

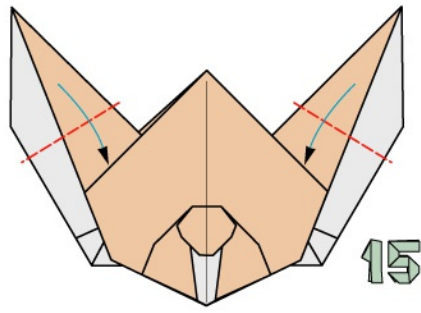

2 pieghe a valle

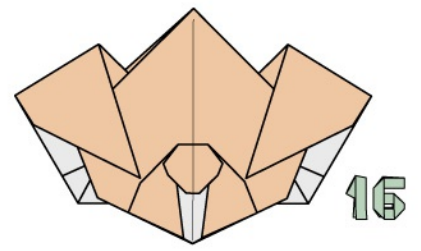

Testa ultimata

COSTRUZIONE DEL CORPO

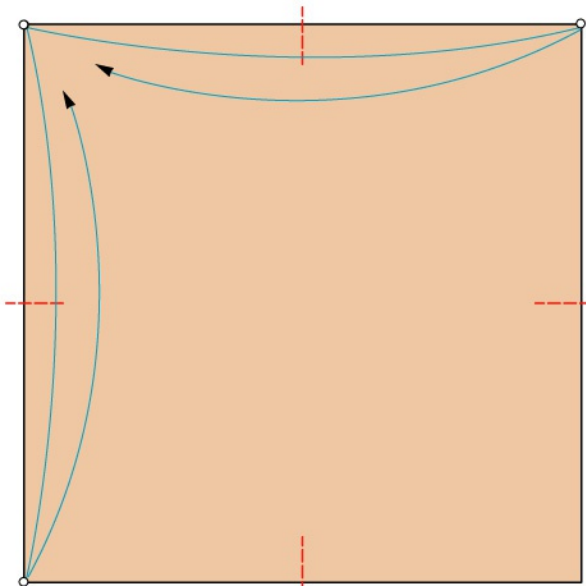

4 piccole pieghe a valle

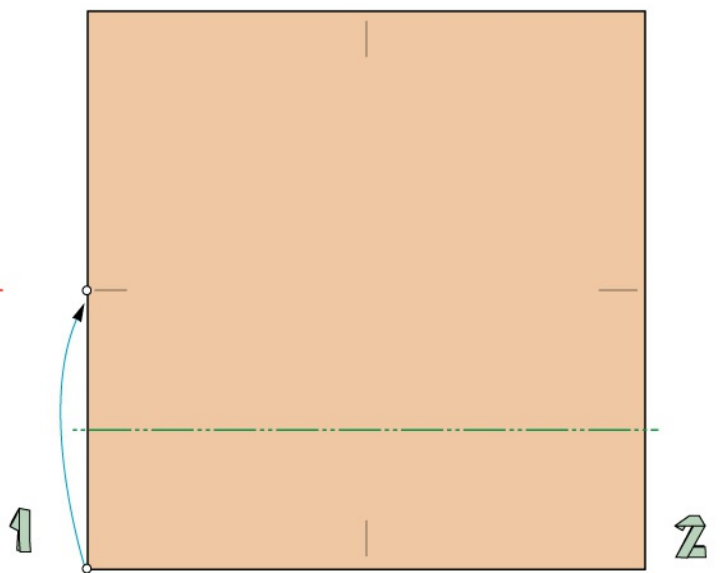

1 piega a monte

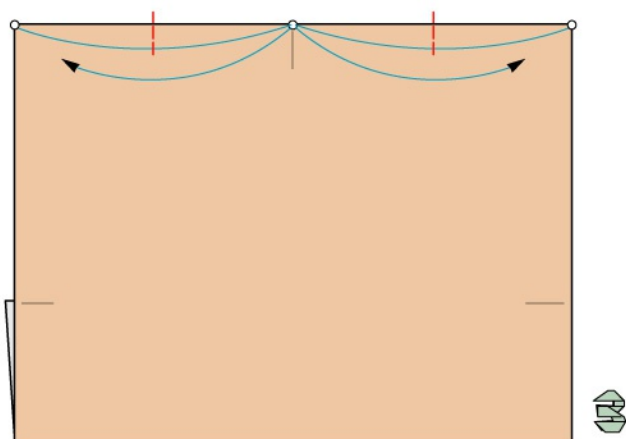

2 piccole pieghe a valle

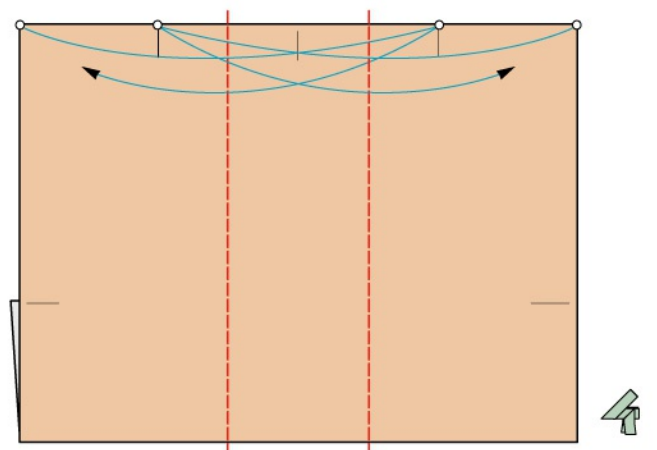

2 pieghe a valle

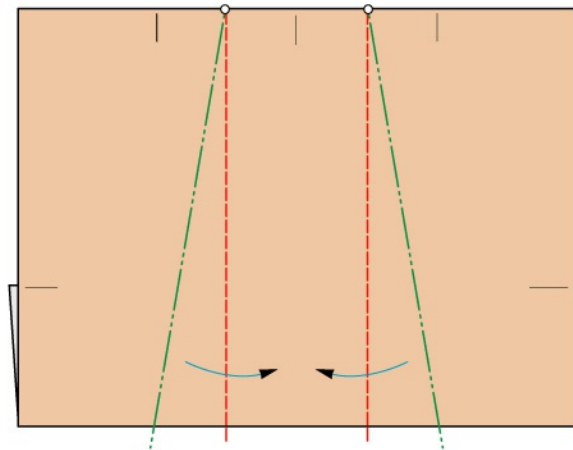

2 pieghe a valle e ripiegate a monte

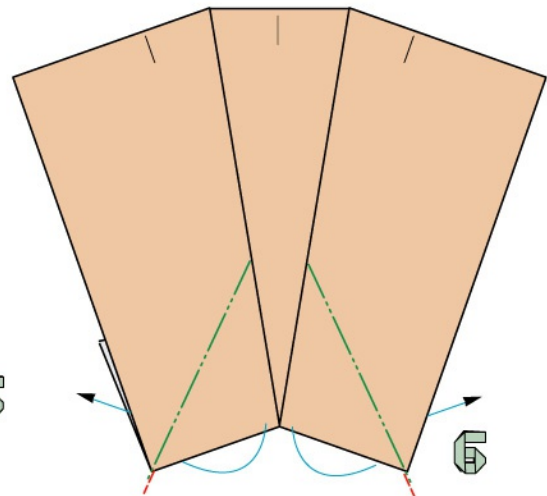

2 pieghe rovesce interne

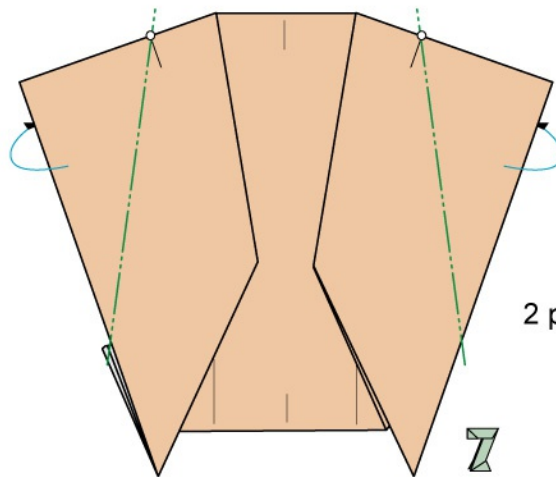

2 pieghe a monte

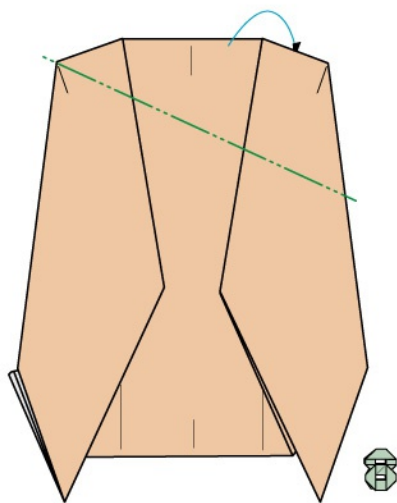

1 piega a monte

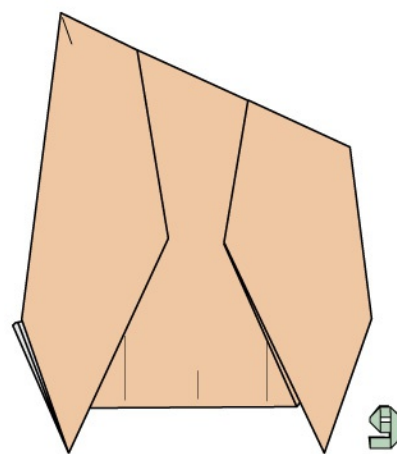

Corpo ultimato

UNIONE DELLA TESTA CON IL CORPO

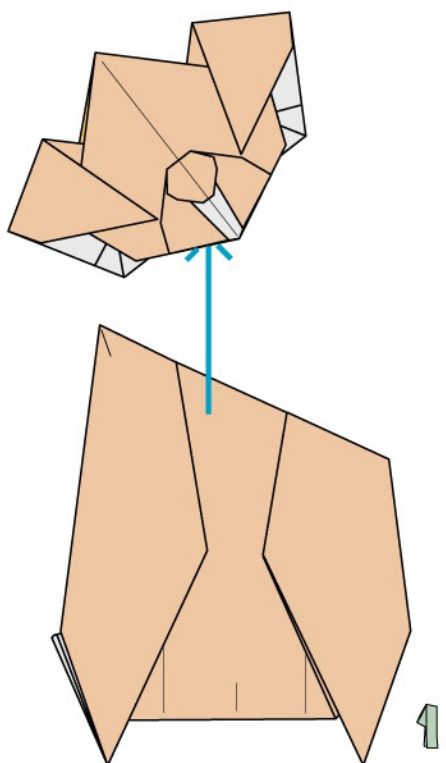

Inserite il corpo nella tasca della testa

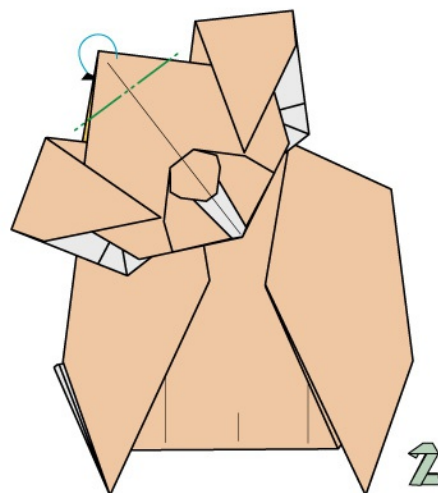

Con una piega a monte bloccate l'unione

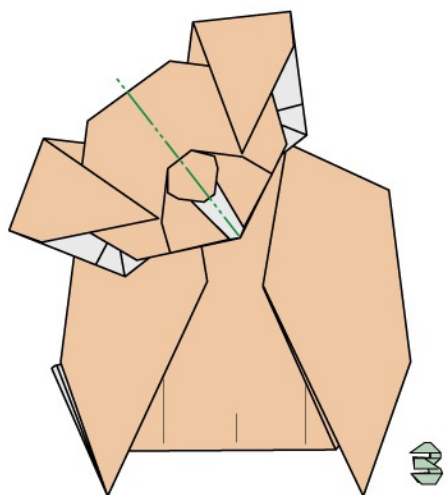

Ripiegate a monte

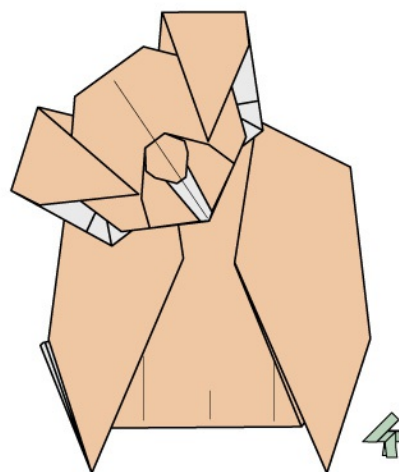

Maialino ultimato

PECHINESE

Adoperate 2 fogli uguali quadrati bicolori, 1 per la costruzione della testa ed 1 per la costruzione del corpo, che si uniscono mediante un idoneo bloccaggio.



COSTRUZIONE DELLA TESTA

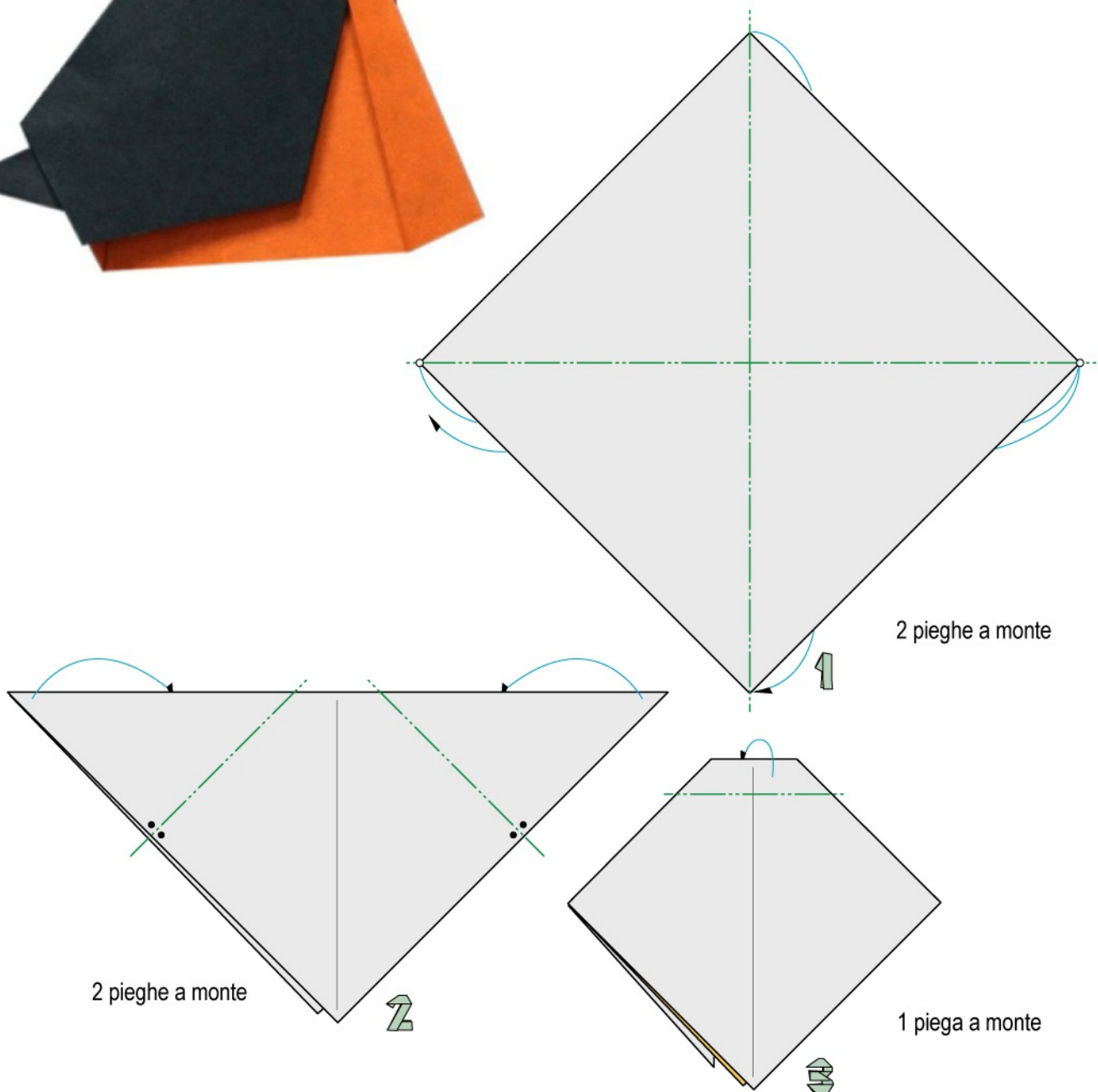

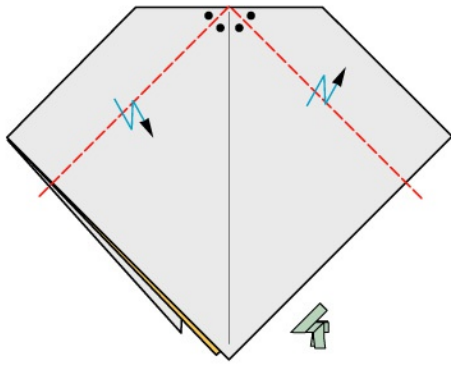

2 pieghe a valle

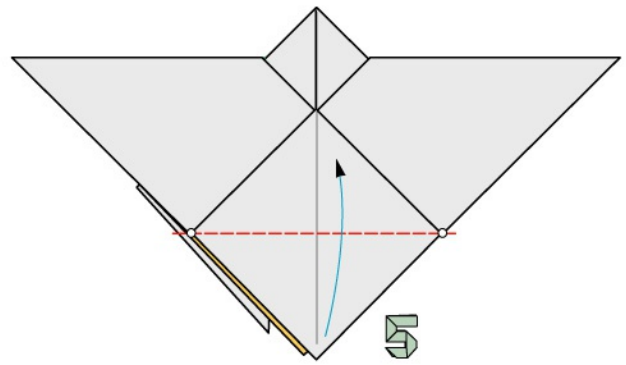

1 piega a valle

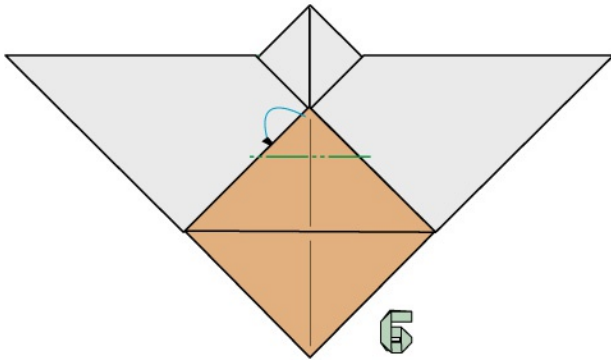

1 piega a monte

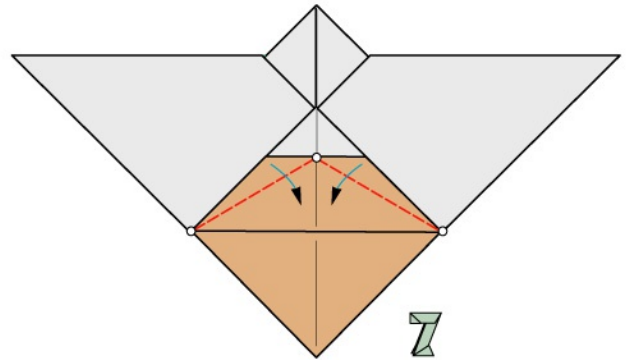

2 pieghe a valle

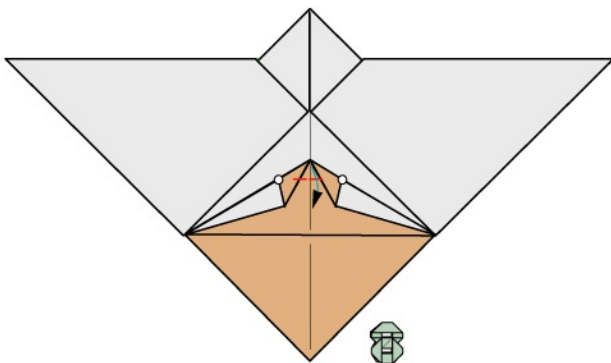

1 piega a valle

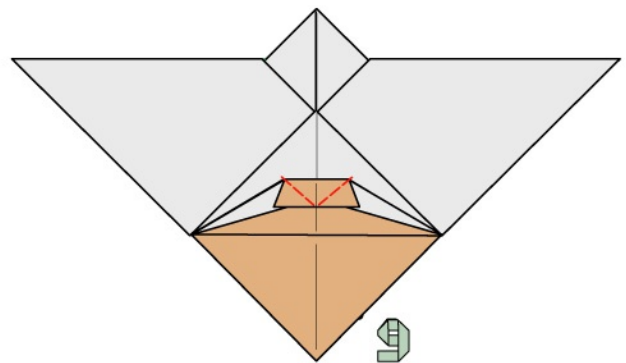

2 pieghe a valle

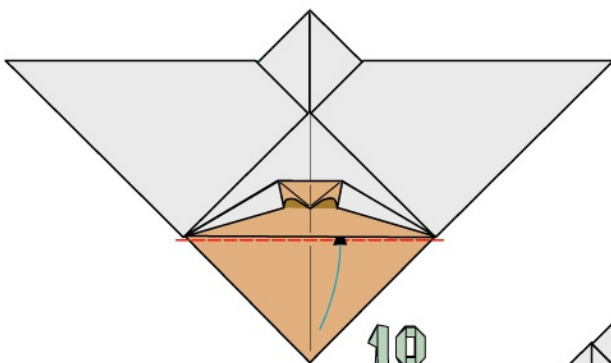

1 piega a valle

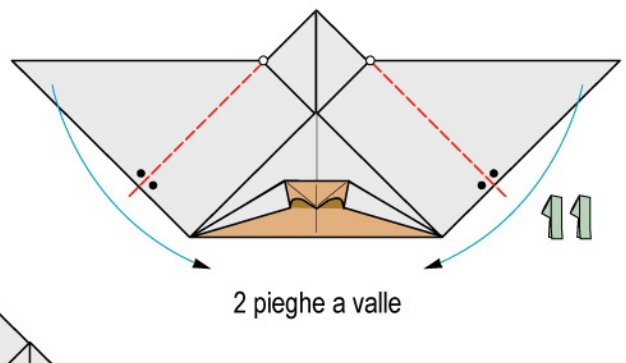

2 pieghe a valle

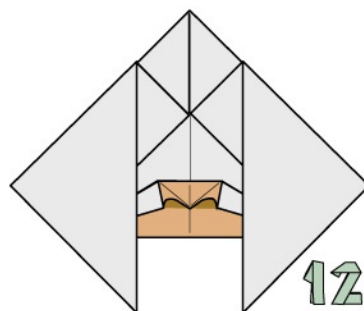

Testa ultimata

COSTRUZIONE DEL CORPO

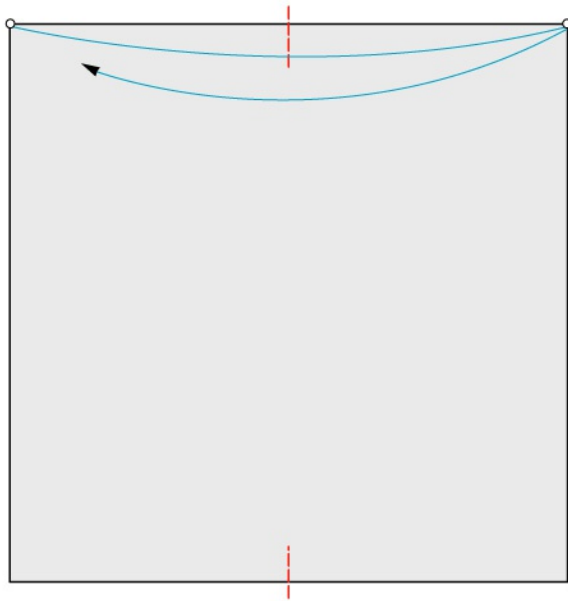

2 piccole pieghe a valle

1

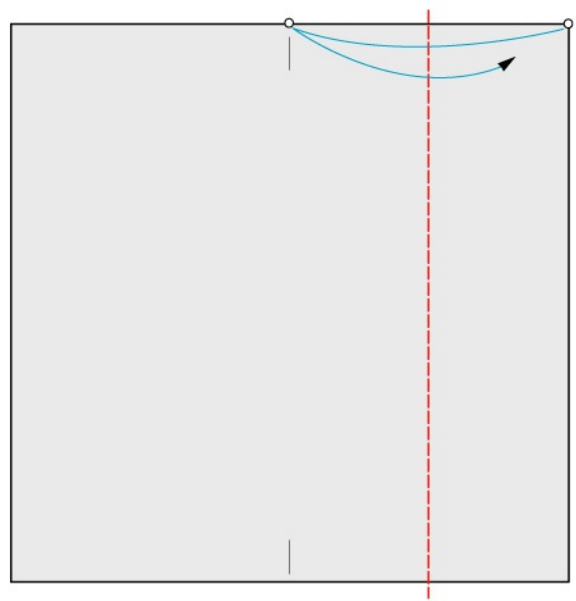

1 piega a valle

2

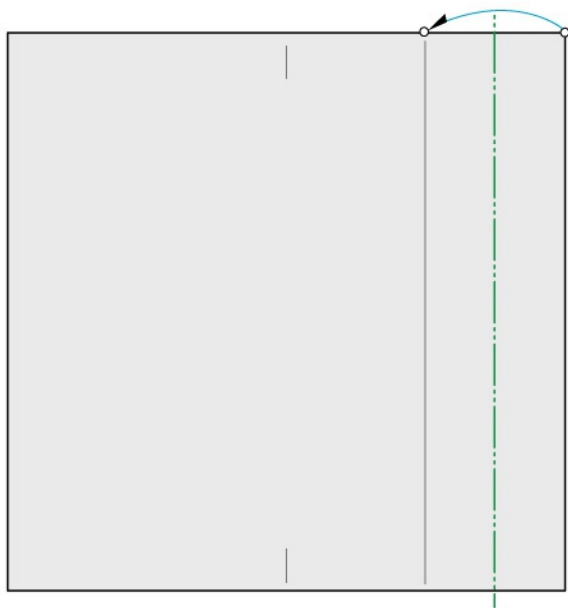

1 piega a monte

3

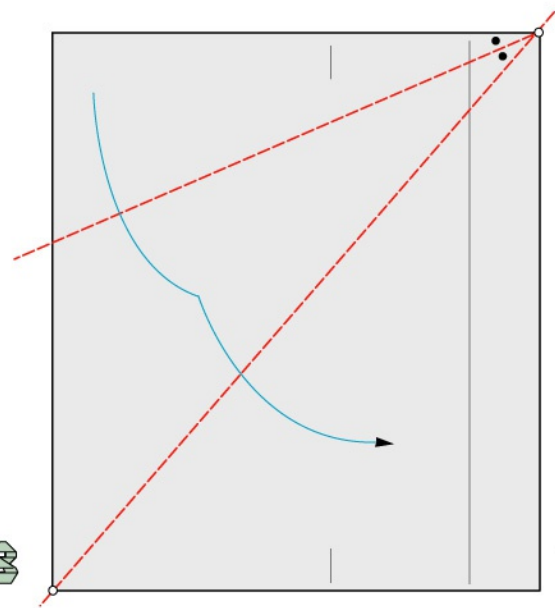

2 pieghe a valle

4

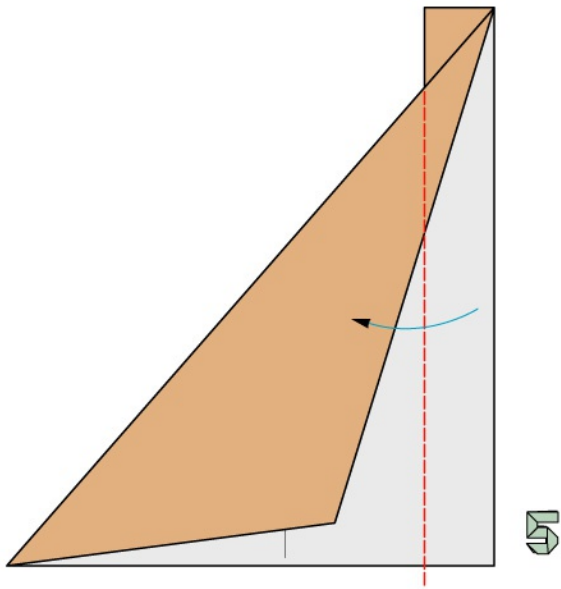

1 piega a valle

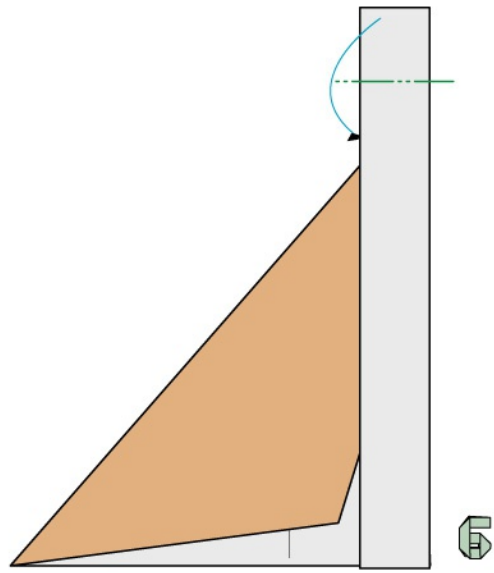

1 piega a monte

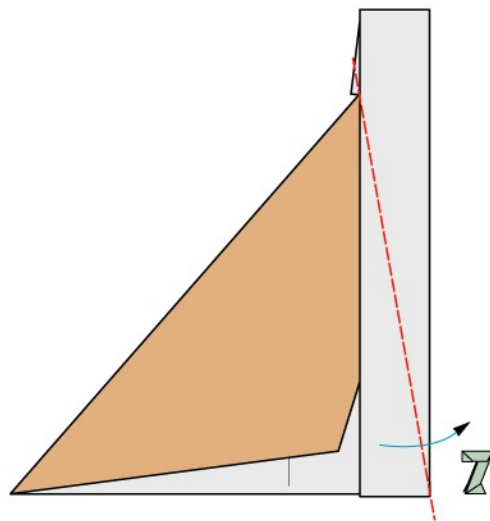

1 piega a valle

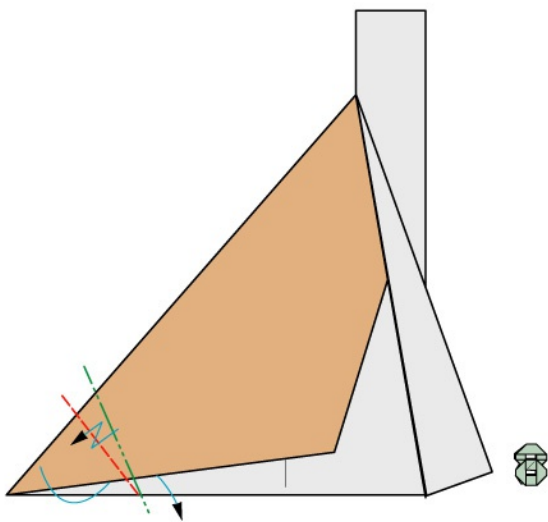

1 piega rovescia interna

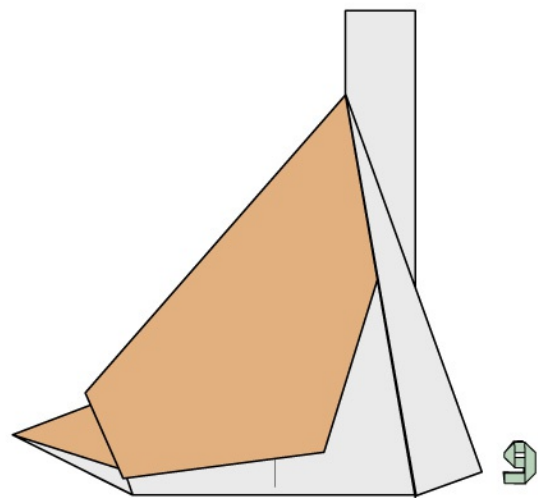

Corpo ultimato

UNIONE DELLA TESTA CON IL CORPO

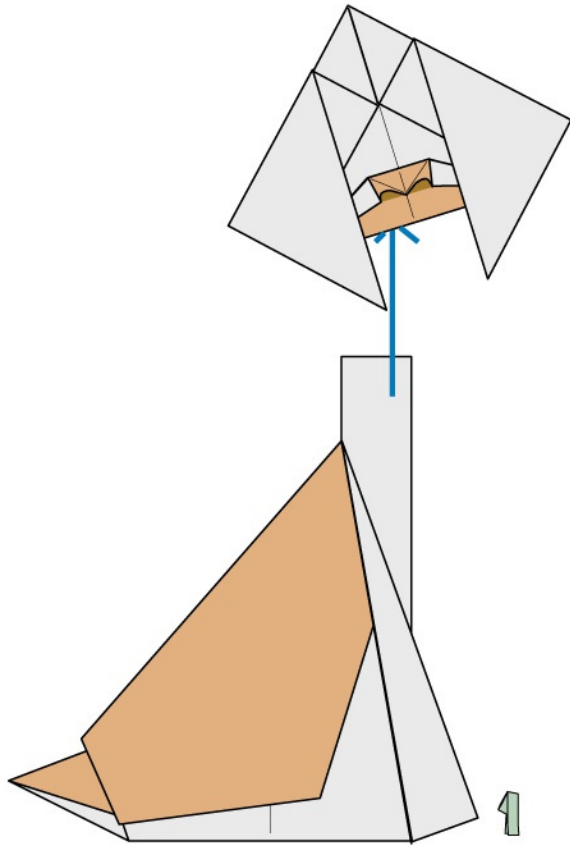

Inserite il corpo nella tasca della testa

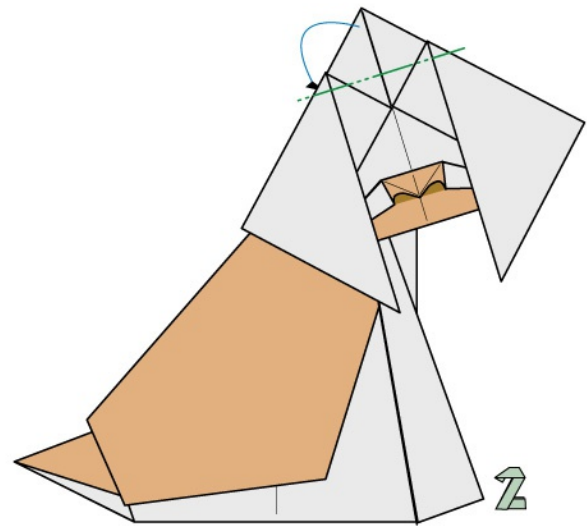

Con una piega a monte bloccate l'unione

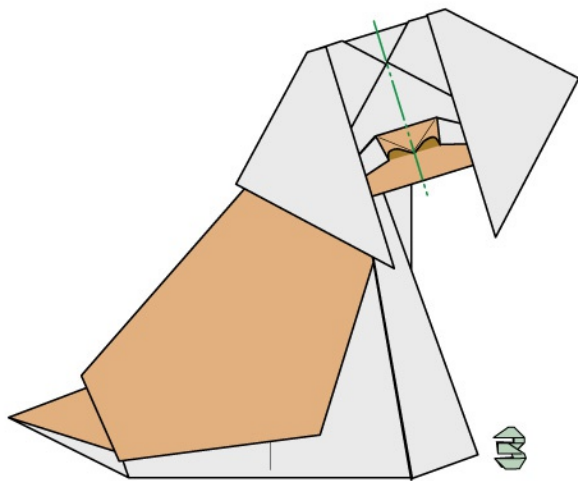

Una piega a monte

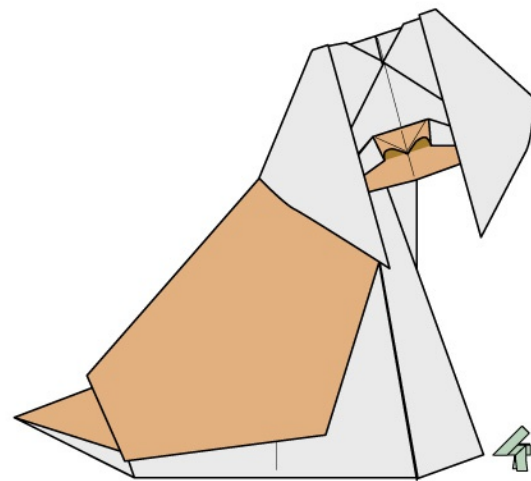

Cane pechinese ultimato

ASINELLO

Adoperate 2 fogli uguali quadrati bicolori,
1 per la costruzione della testa ed 1 per
la costruzione del corpo, che si uniscono
mediante un idoneo bloccaggio.



COSTRUZIONE DELLA TESTA

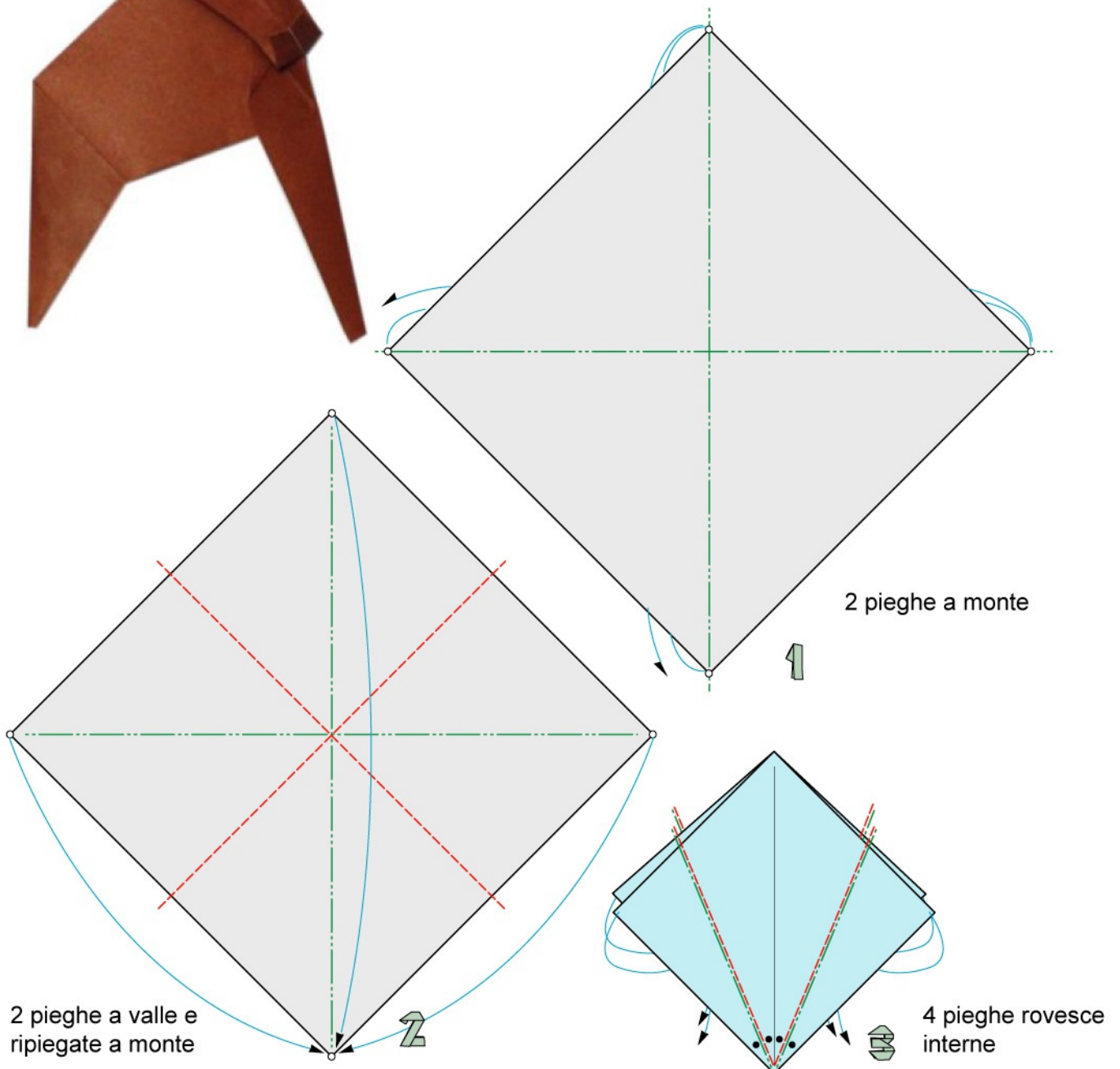

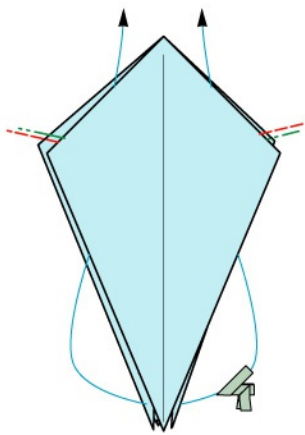

2 pieghe rovesce interne

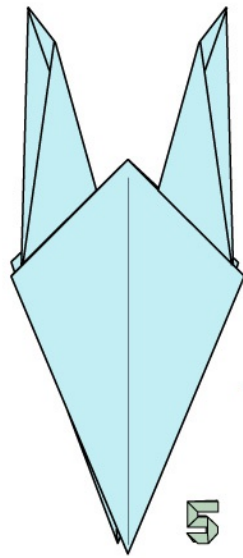

Ribaltate

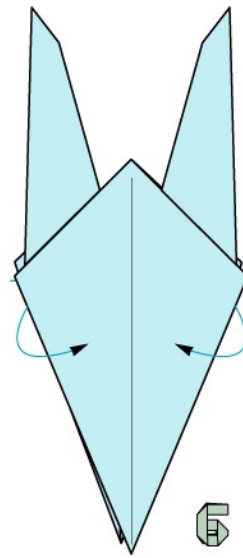

2 pieghe rovesce esterne

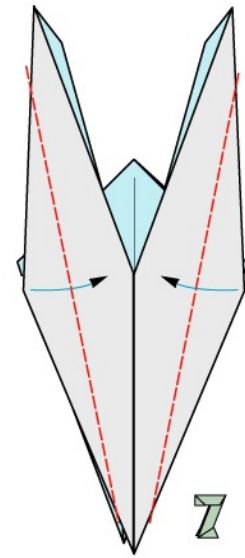

2 pieghe a valle

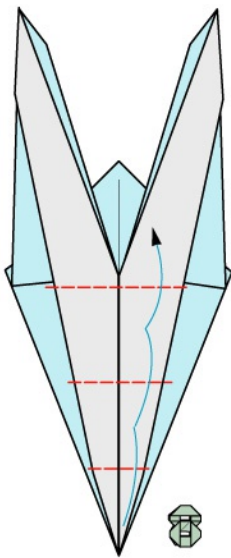

3 pieghe a valle

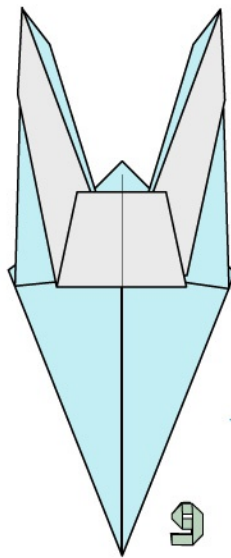

Ribaltate

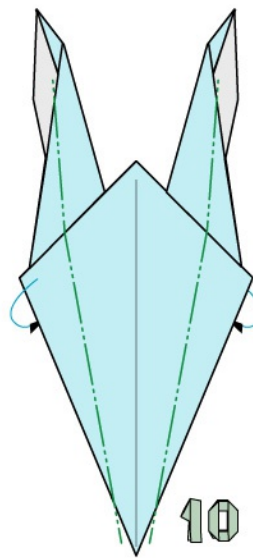

2 pieghe a monte

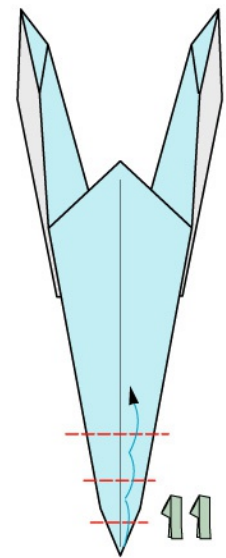

3 pieghe a valle

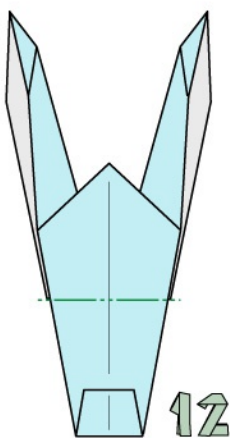

1 piega a monte

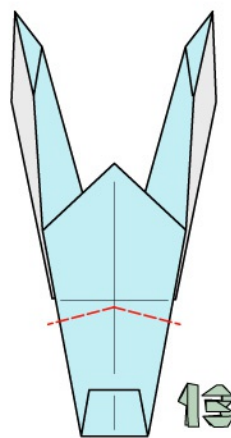

1 piega a valle

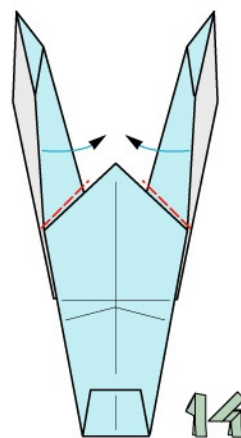

2 pieghe a valle per aprire le orecchie

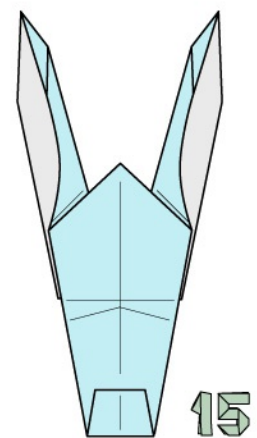

Testa ultimata

COSTRUZIONE DEL CORPO

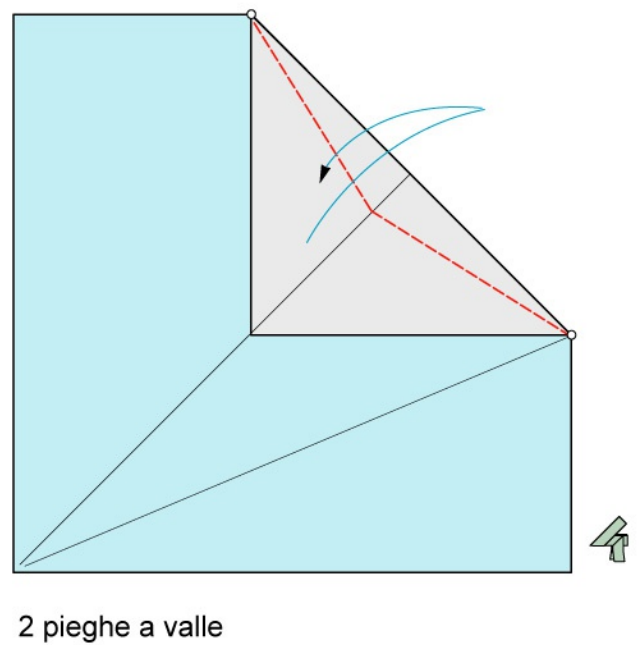
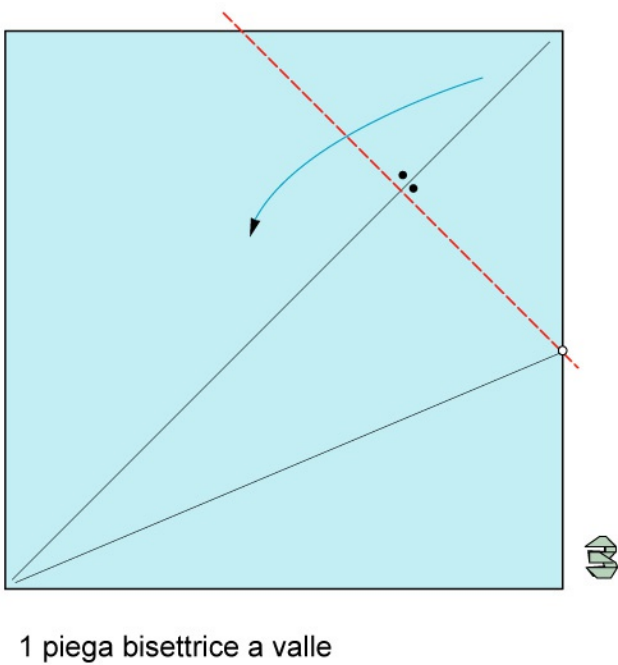
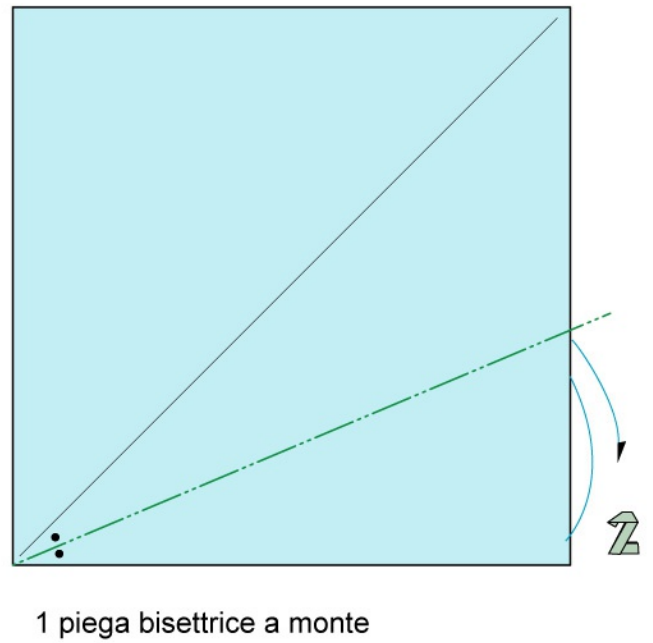
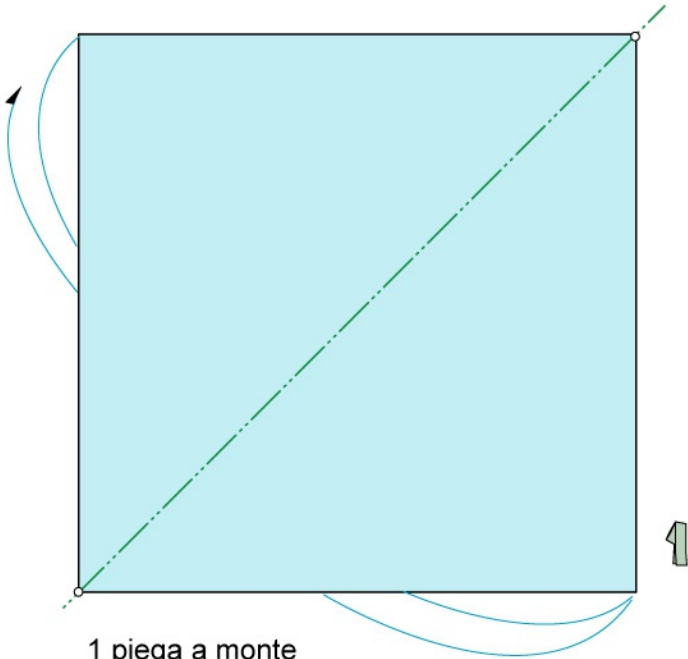

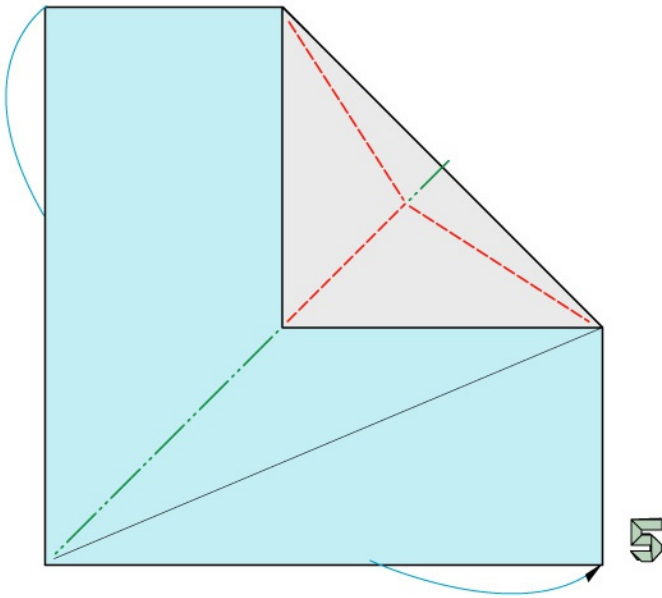

Ripiegate a monte ed a valle

5

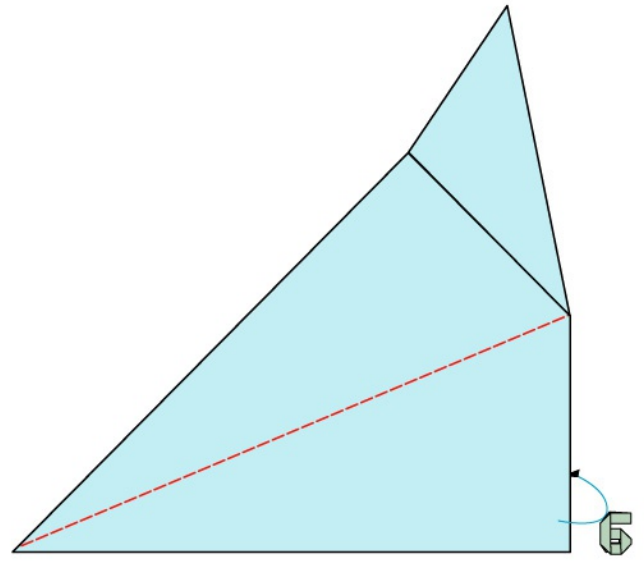

1 piega a valle

6

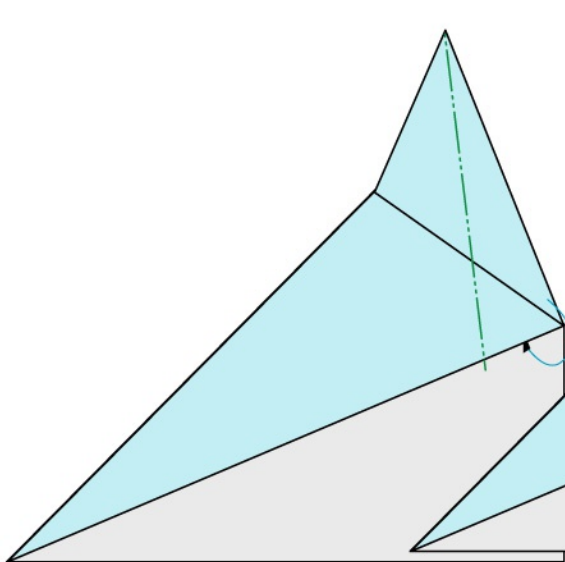

1 piega a monte

7

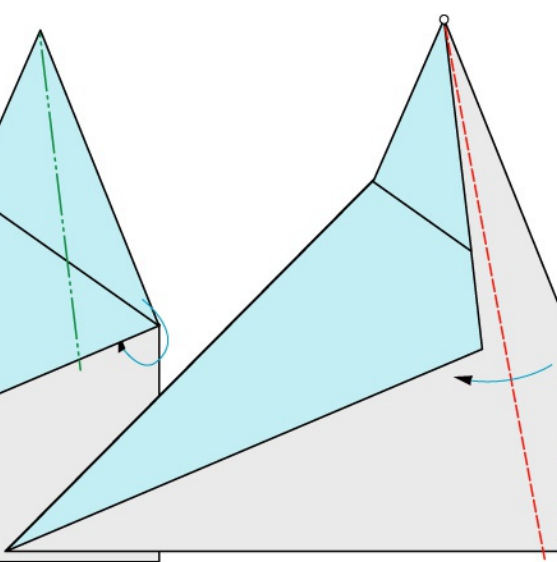

1 piega a valle

8

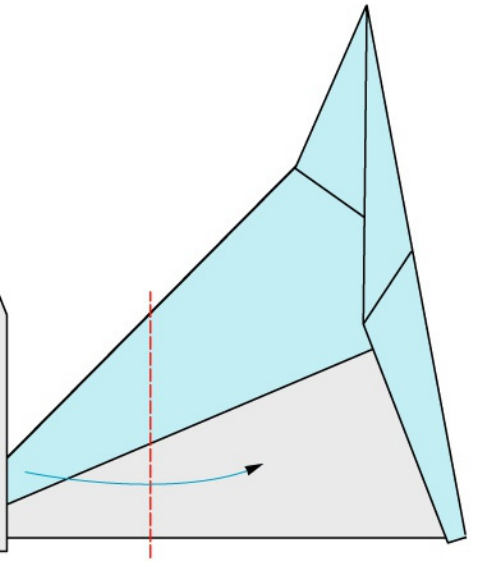

1 piega a valle

9

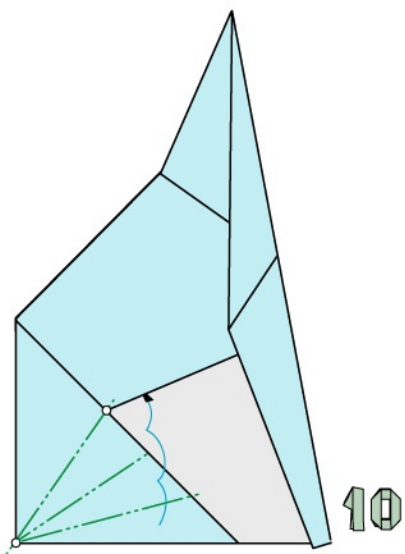

3 pieghe a monte

10

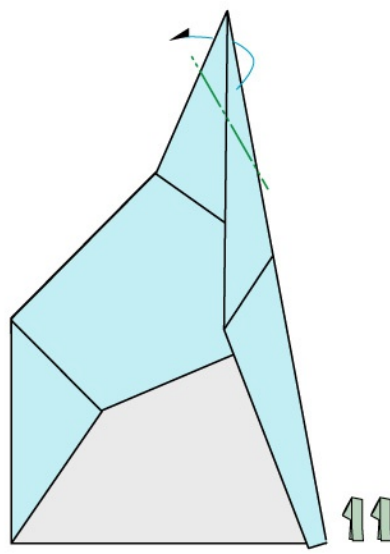

1 piega a monte

11

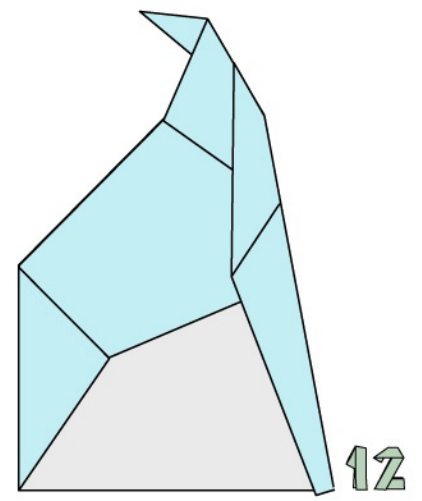

Corpo ultimato

12

UNIONE DELLA TESTA CON IL CORPO

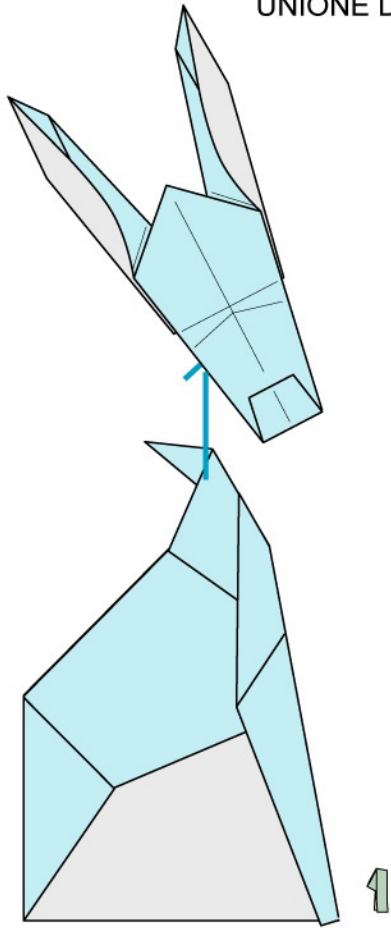

Inserite il corpo nella tasca della testa

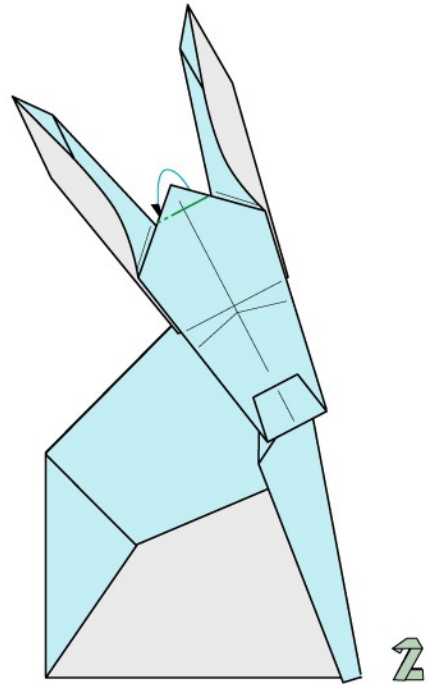

Con una piega a monte bloccate l'unione

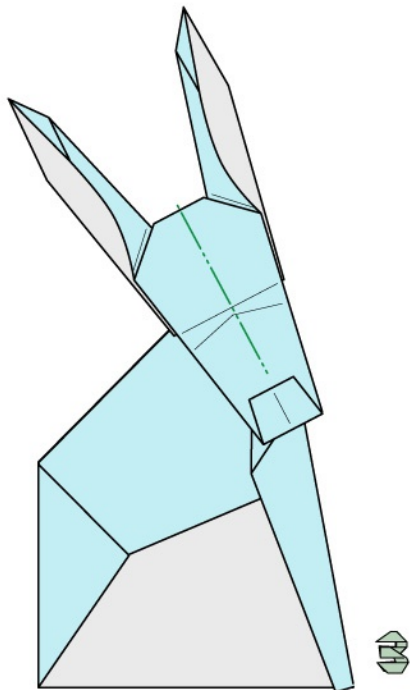

Ripiegate a monte

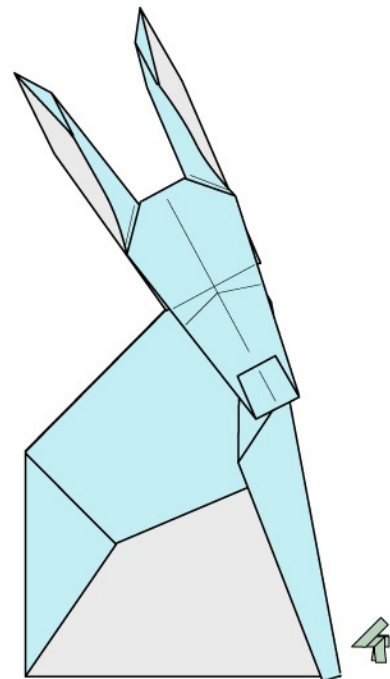

Asinello ultimato

PINGUINO

Adoperare 2 fogli quadrati bicolori, 1 di dimensioni doppie dell'altro, 1 per la costruzione della testa ed 1 per la costruzione del corpo, che si uniscono mediante un idoneo bloccaggio.

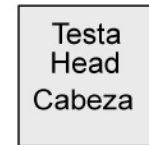
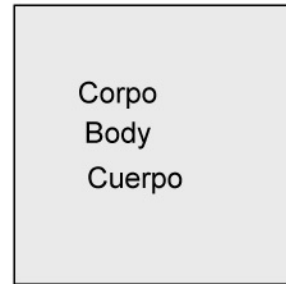

COSTRUZIONE DELLA TESTA

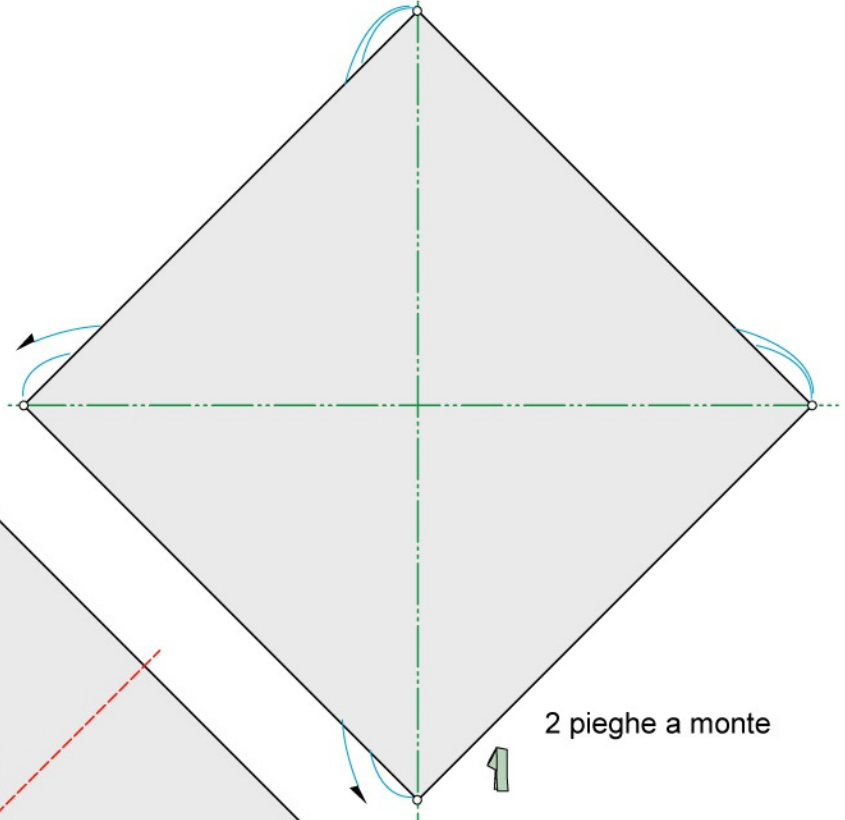

2 pieghe a monte

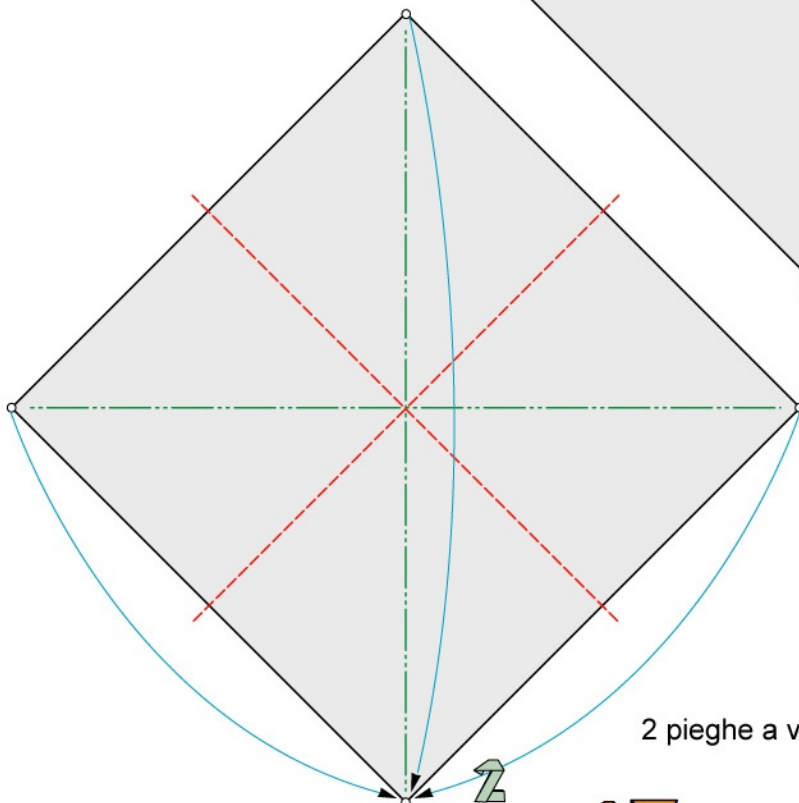

2 pieghe a valle e ripiegate a monte

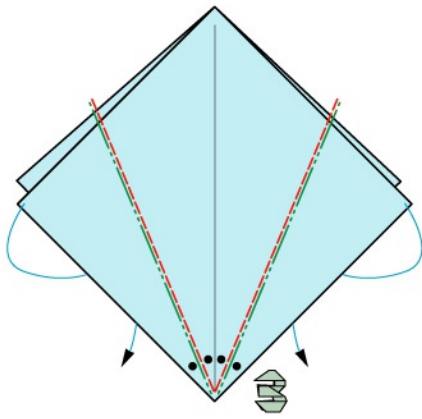

2 pieghe rovesce interne

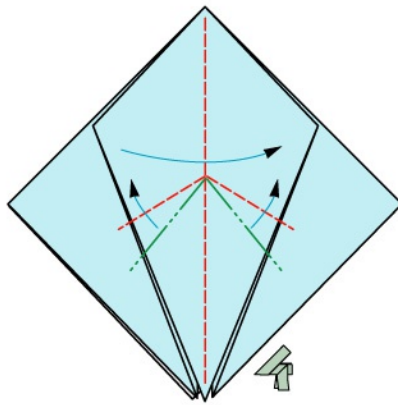

3 pieghe a valle e 2 a monte

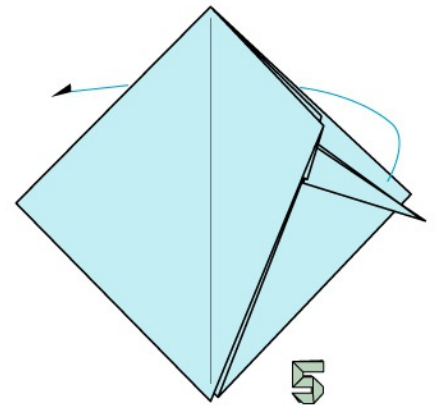

Ruotate l'aletta

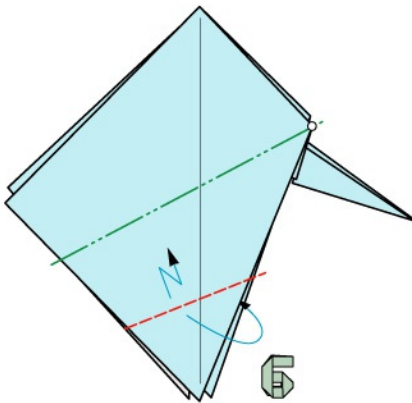

1 piega rovescia interna

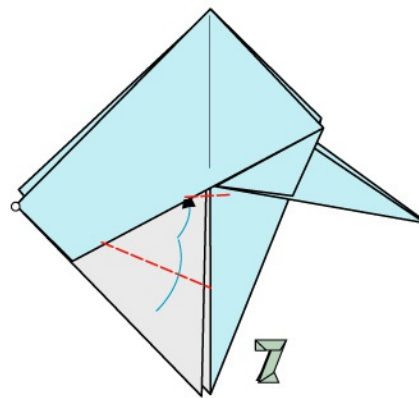

2 pieghe a valle ed intascate

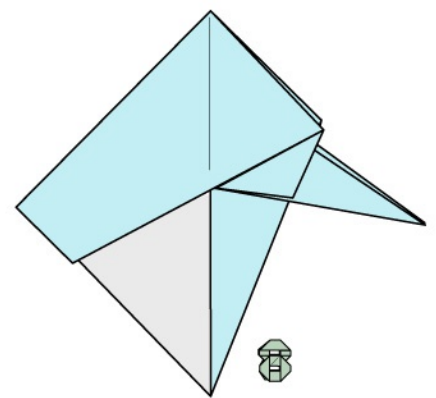

Testa ultimata

UNIONE DELLA TESTA CON IL CORPO

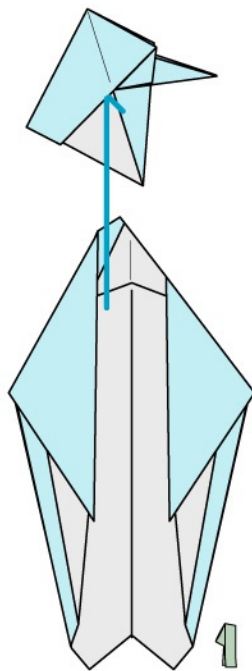

Inserite il corpo nella tasca della testa

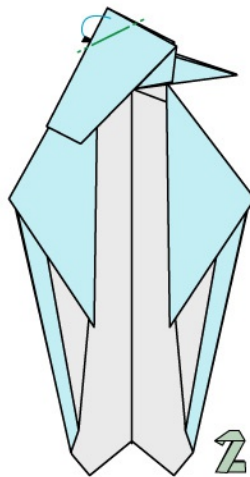

Con una piega a monte bloccate l'unione

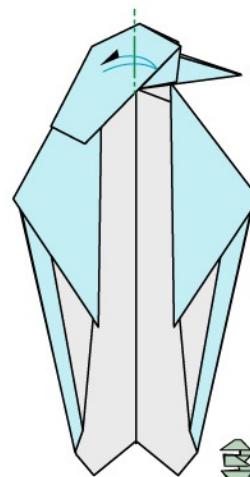

Una piega a monte

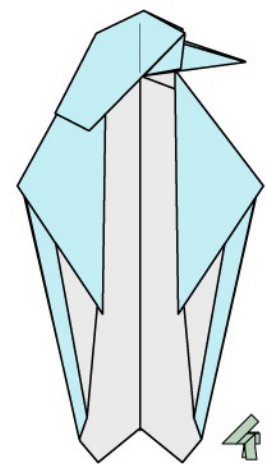

Pinguino ultimato

COSTRUZIONE DEL CORPO

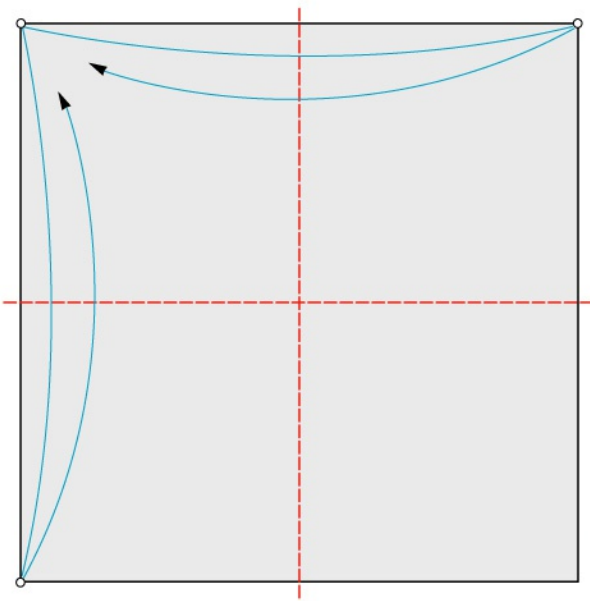

2 pieghe a valle

1

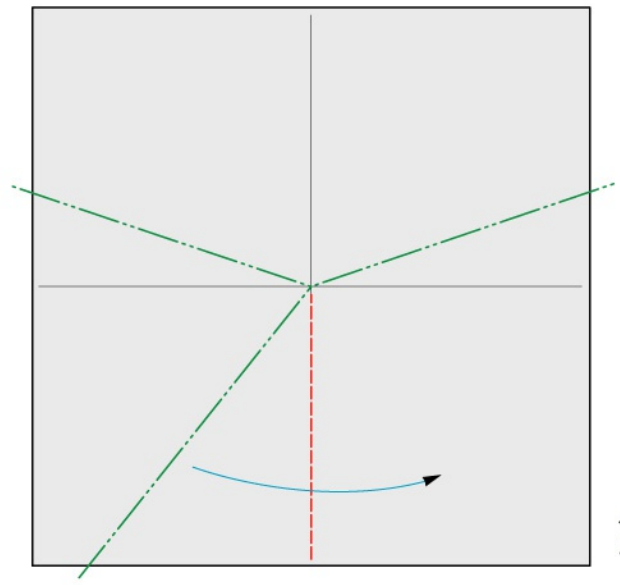

3 pieghe a monte e ripiegate a valle

2

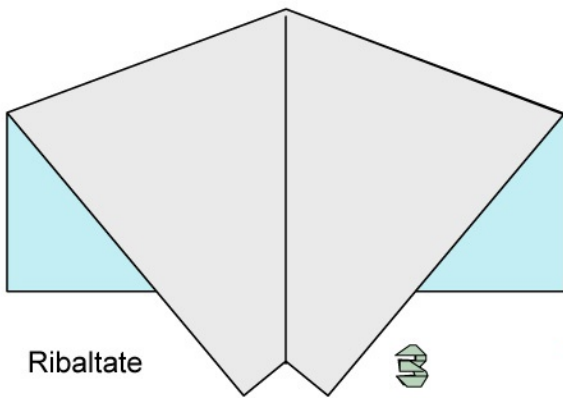

Ribaltate

3

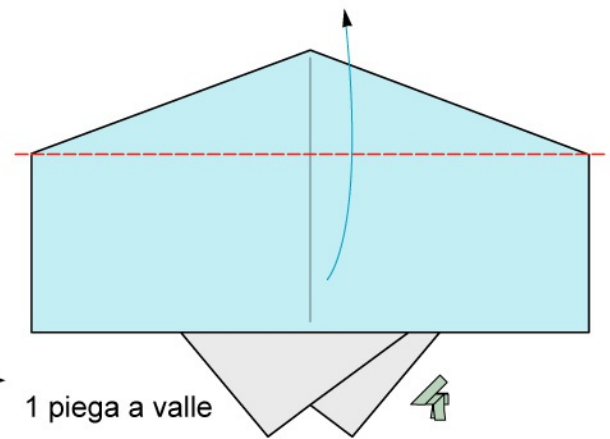

1 piega a valle

4

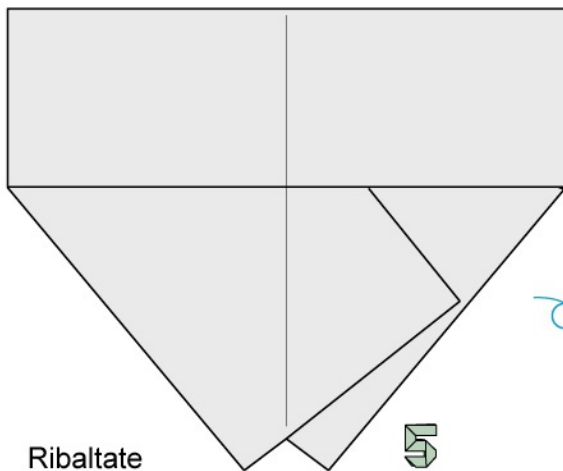

Ribaltate

5

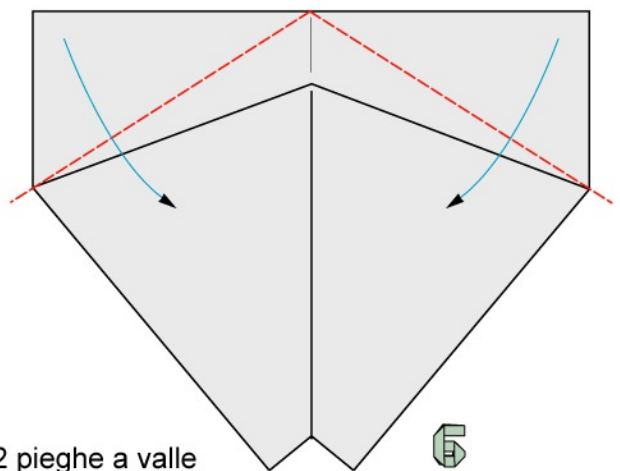

2 pieghe a valle

6

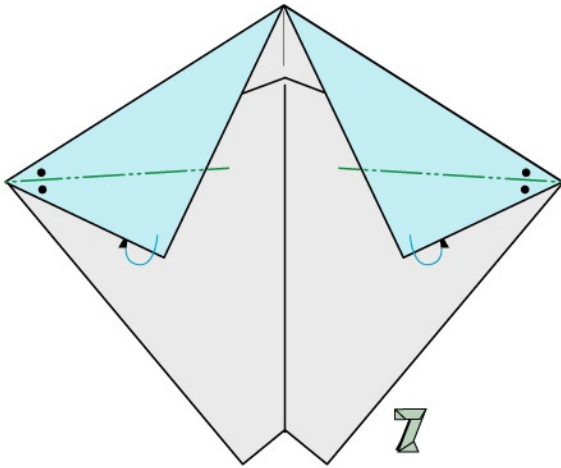

2 pieghe a monte

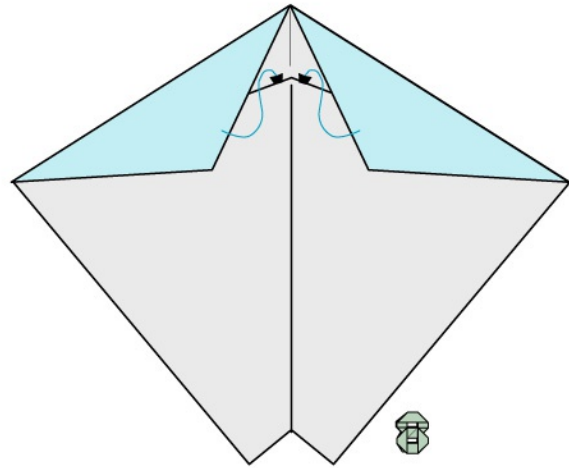

Intascate le 2 alette

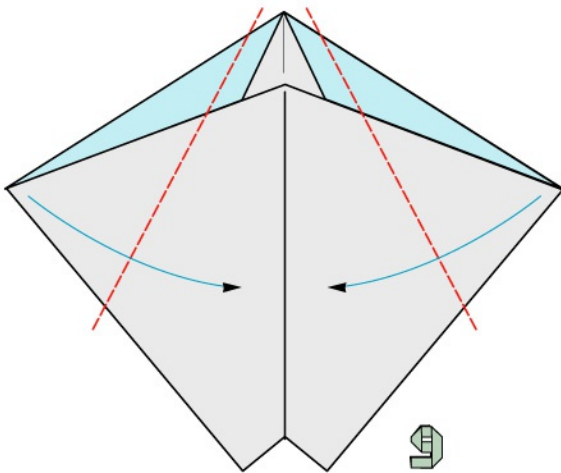

2 pieghe a valle

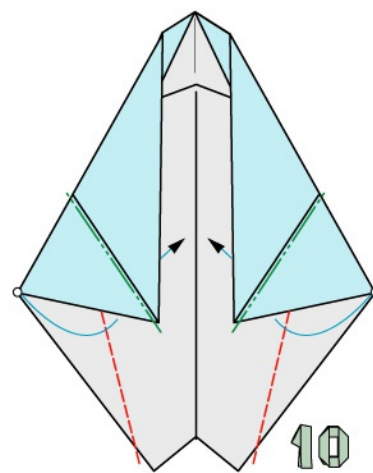

2 rovesce interne

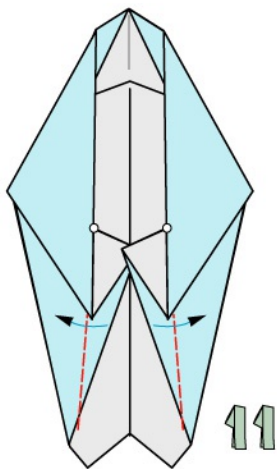

2 pieghe a valle

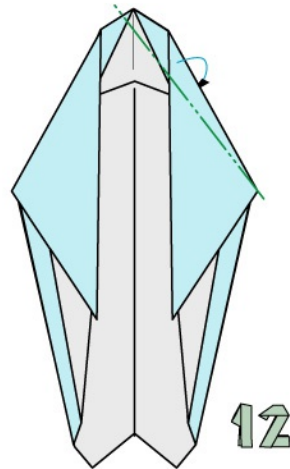

1 piega a monte

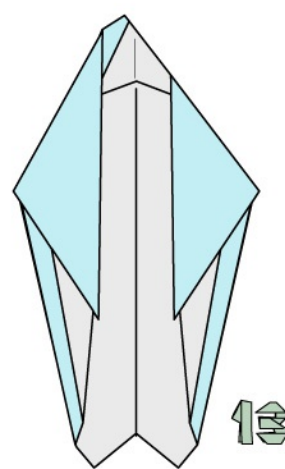

Corpo ultimato

ELEFANTINO

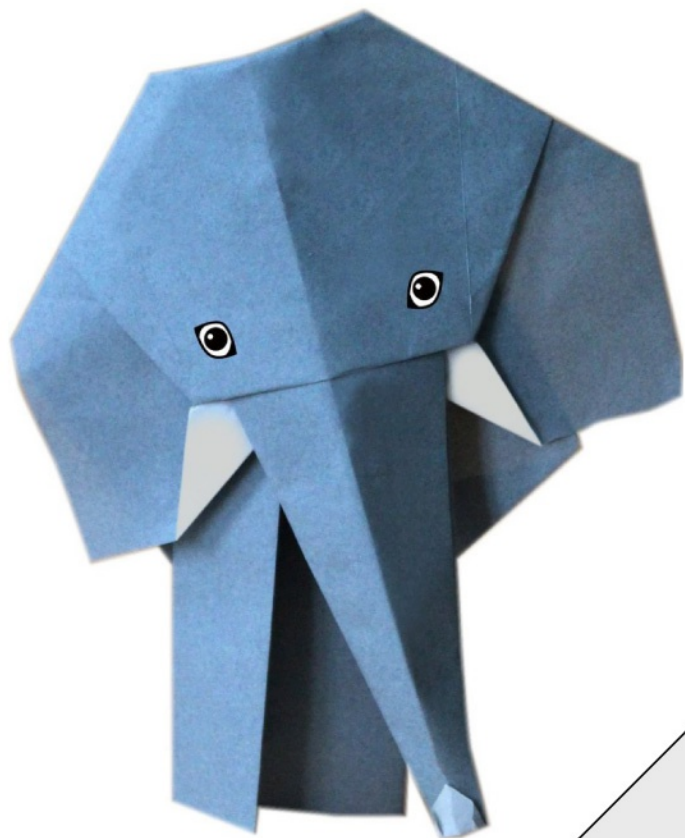

Adoperate 2 fogli uguali quadrati bicolori, 1 per la costruzione della testa ed 1 per la costruzione del corpo, che si uniscono mediante un idoneo bloccaggio.

COSTRUZIONE DELLA TESTA

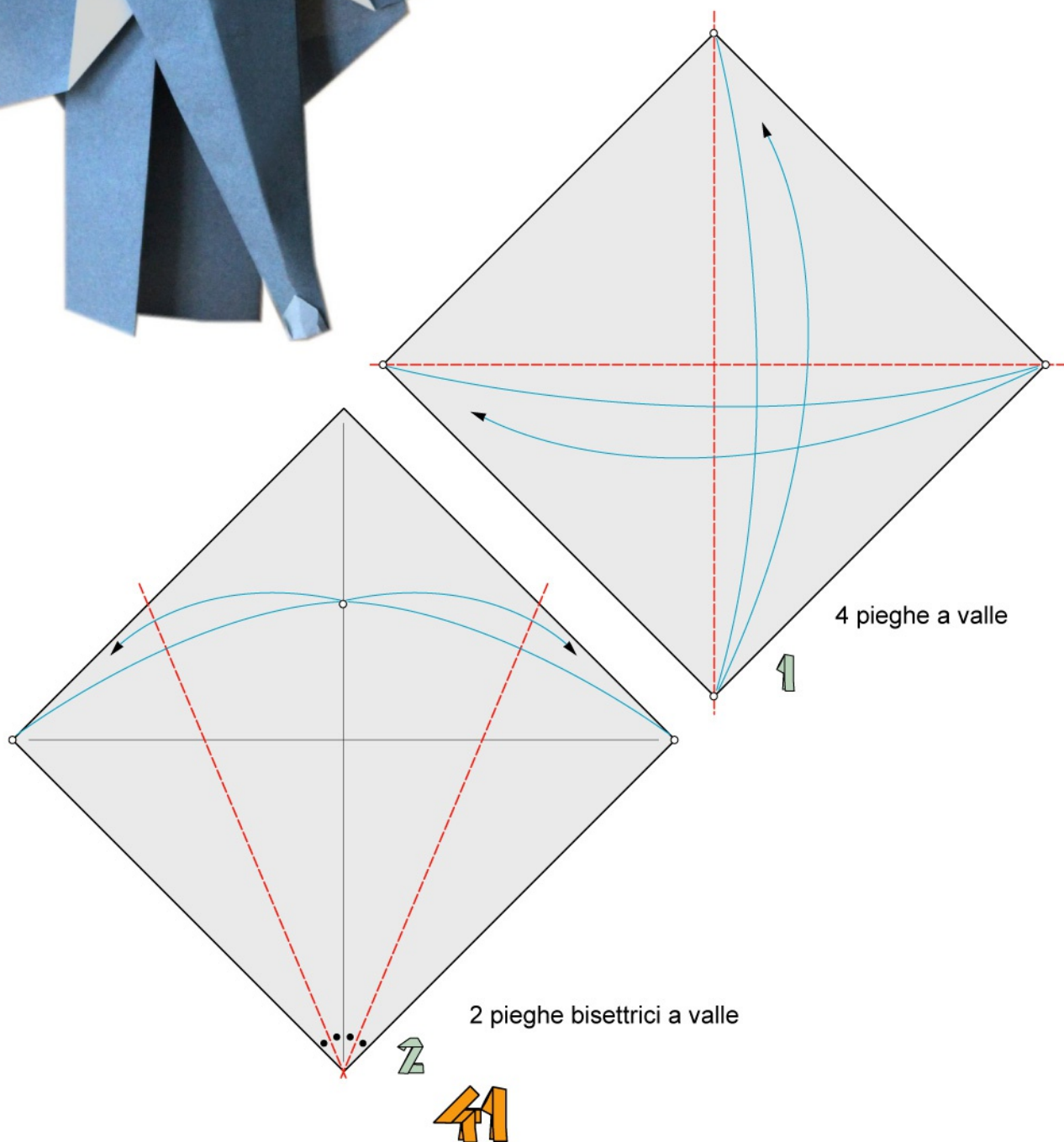

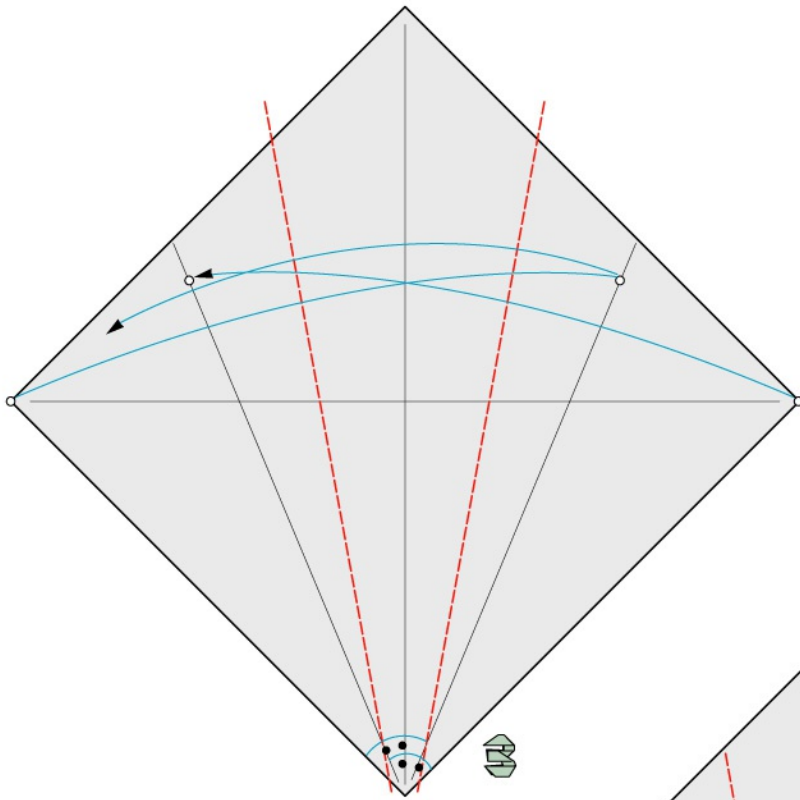

2 pieghe bisettrici a valle

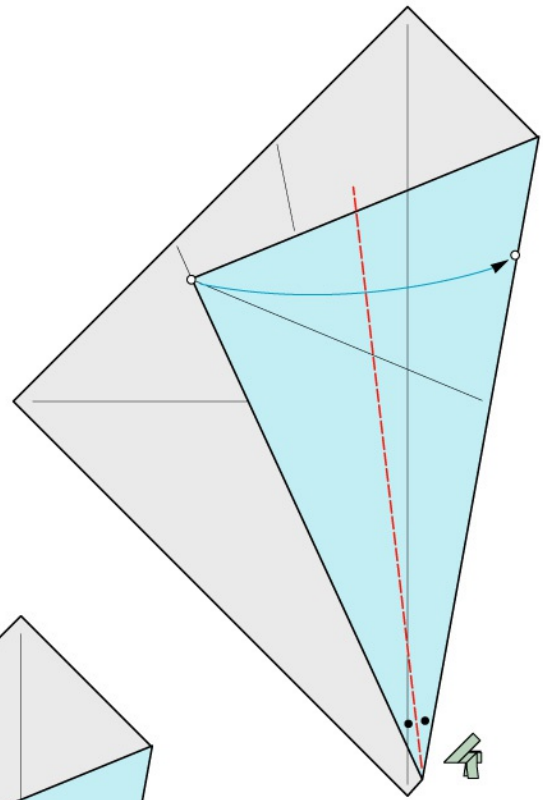

1 piega bisettrice a valle

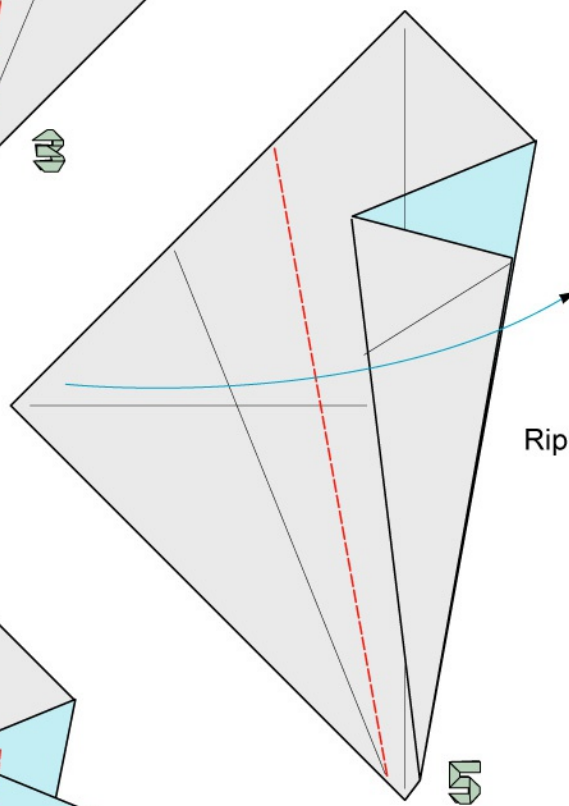

Ripiegate a valle

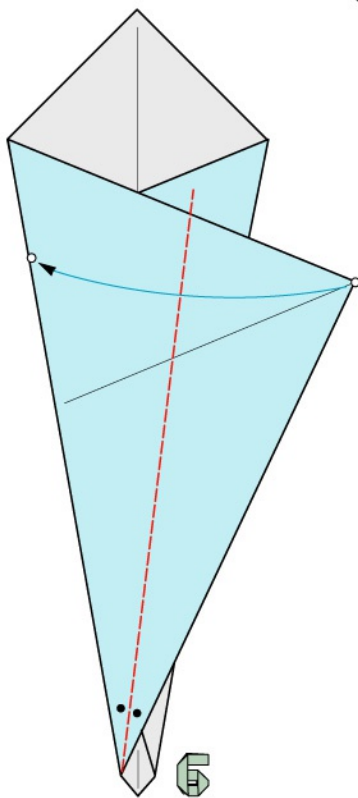

1 piega bisettrice a valle

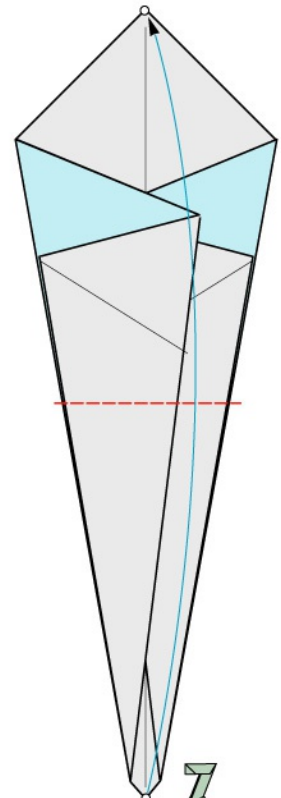

1 piega a valle

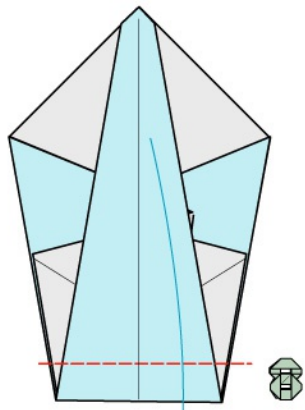

1 piega a valle

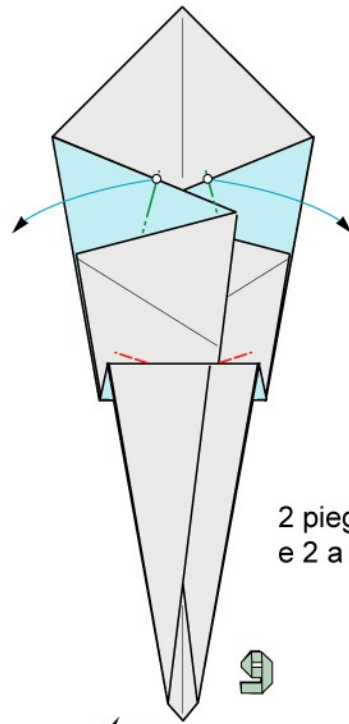

2 pieghe a valle
e 2 a monte

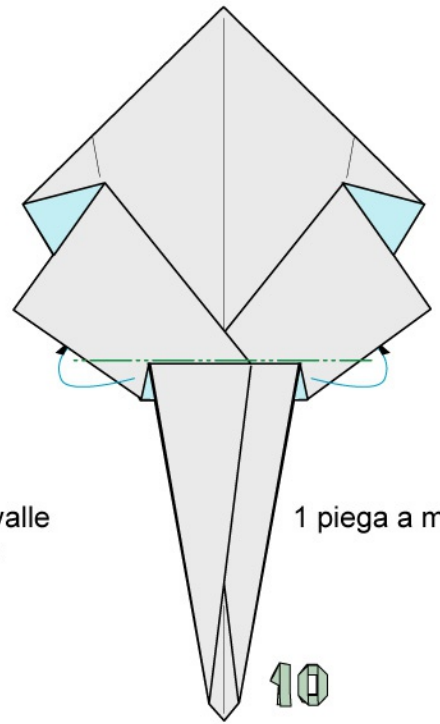

1 piega a monte

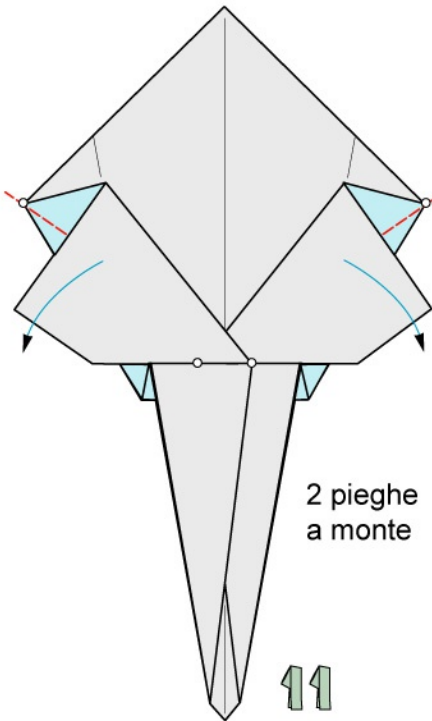

2 pieghe
a monte

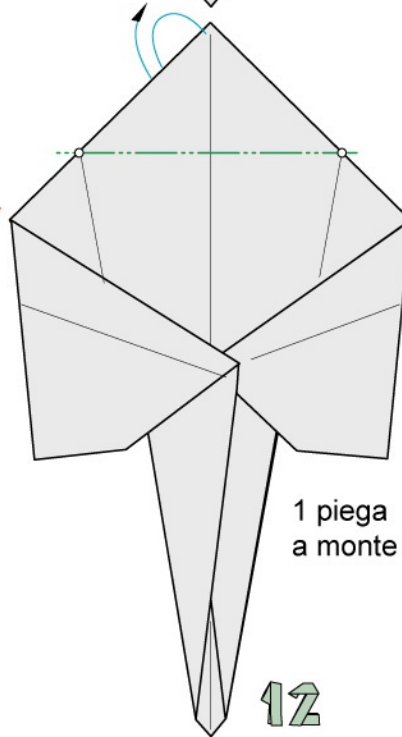

1 piega
a monte

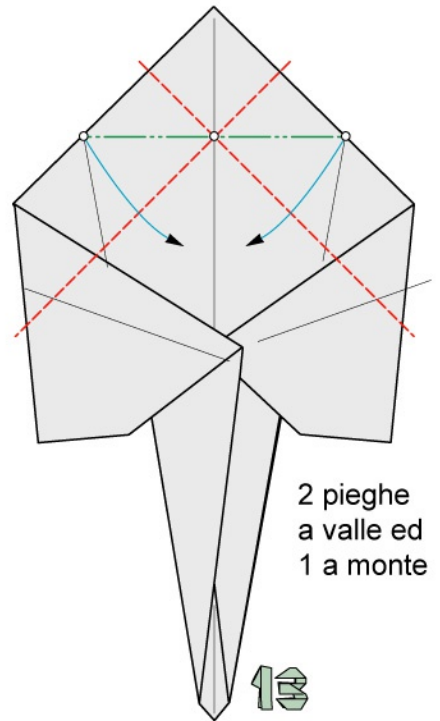

2 pieghe
a valle ed
1 a monte

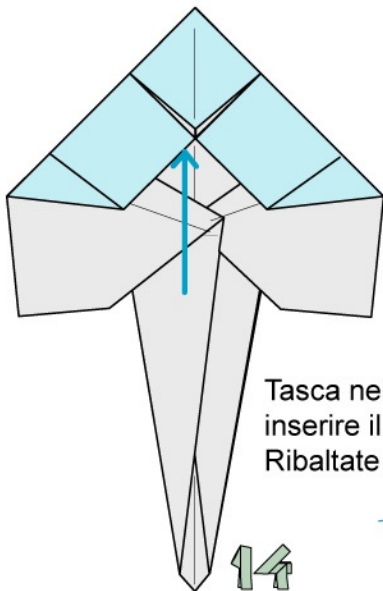

Tasca nella quale
inserire il corpo.
Ribaltate

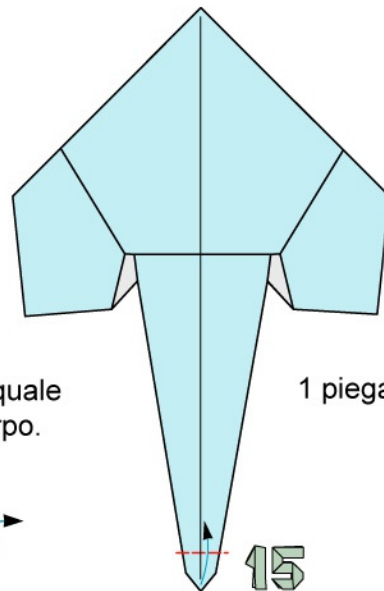

1 piega a valle

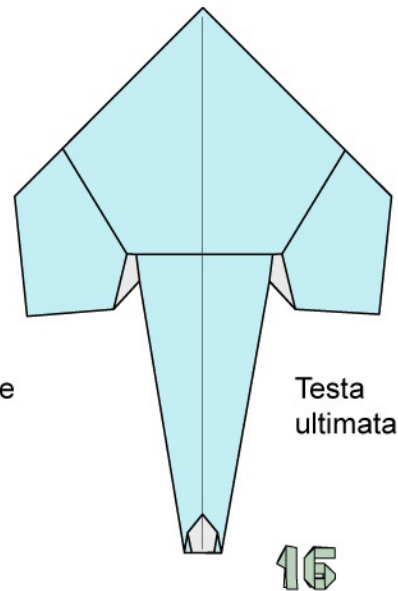

Testa
ultimata



COSTRUZIONE DEL CORPO

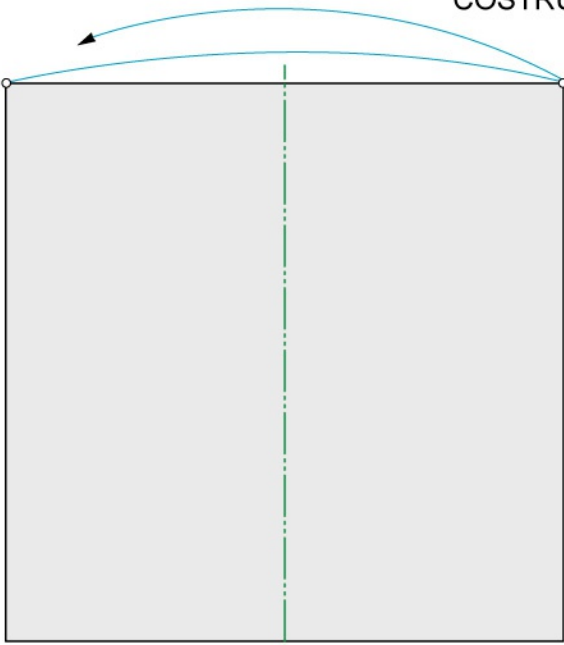

1 piega a monte

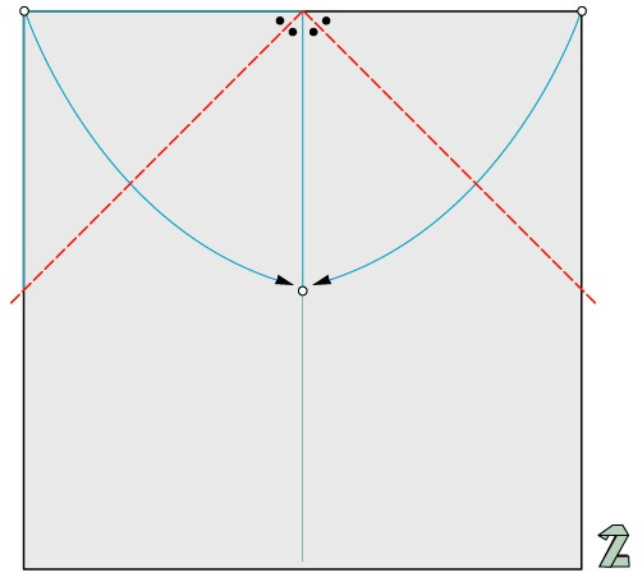

2 pieghe bisettrici a valle

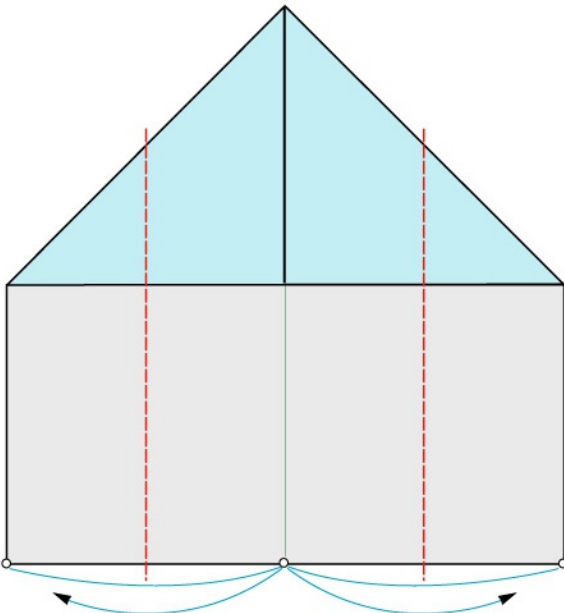

2 pieghe a valle

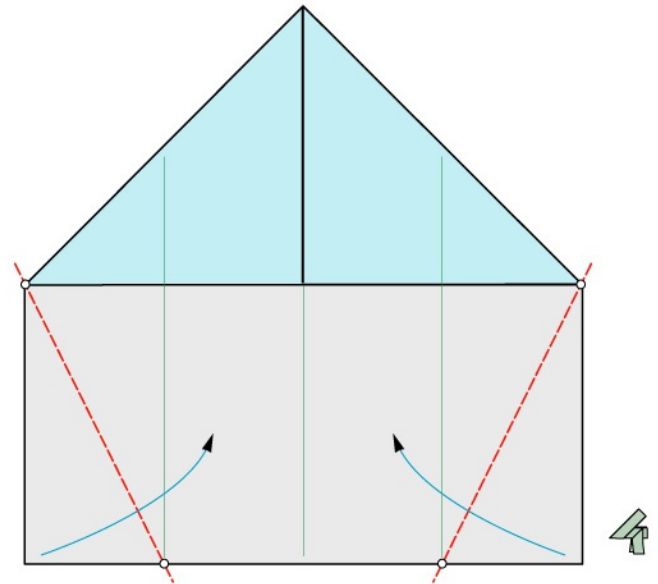

2 pieghe a valle

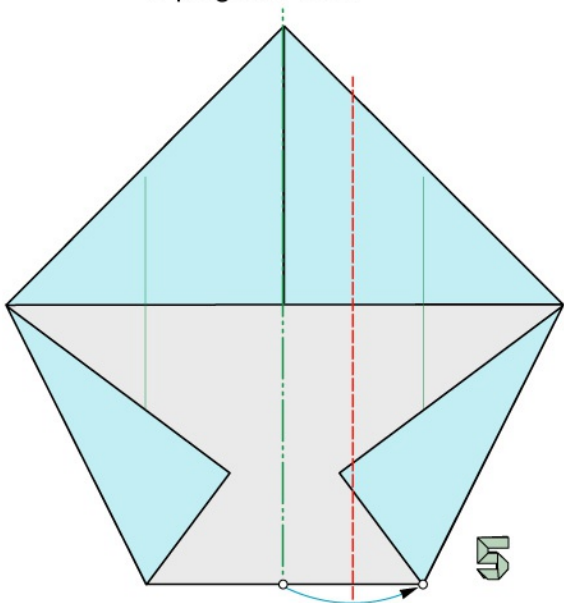

1 piega a valle e ripiegate a monte

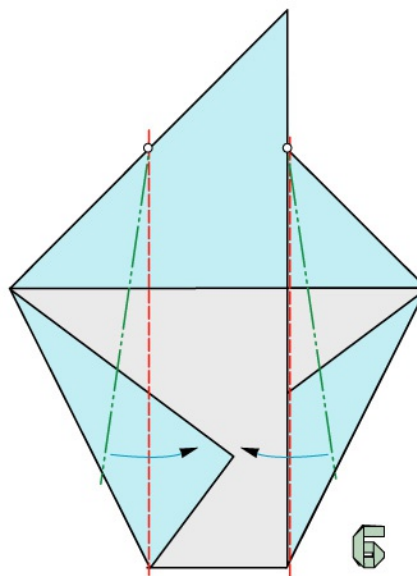

2 pieghe a valle e 2 a monte

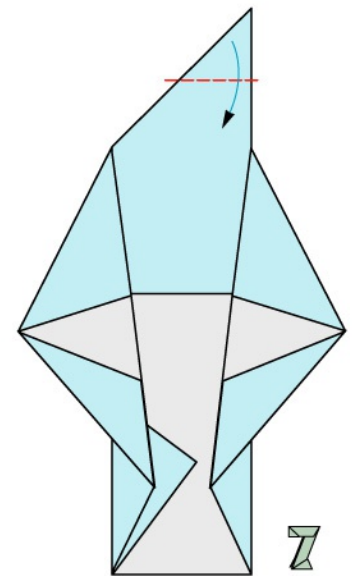

1 piega a valle



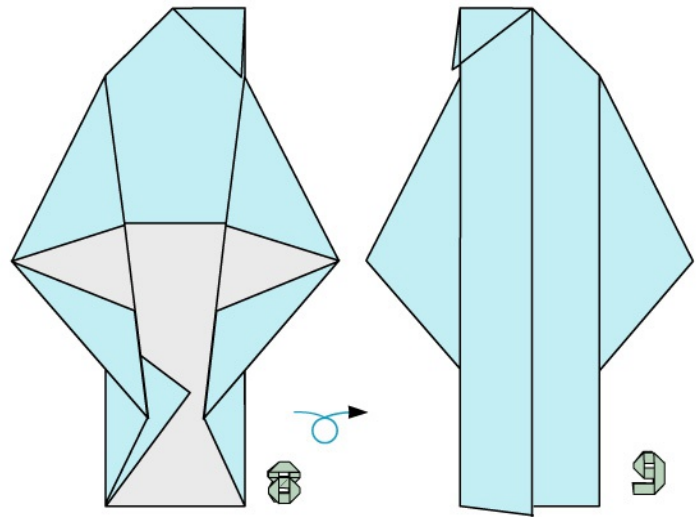

Ribaltate

Corpo ultimato

UNIONE DELLA TESTA CON IL CORPO



Inserite il corpo nella tasca della testa

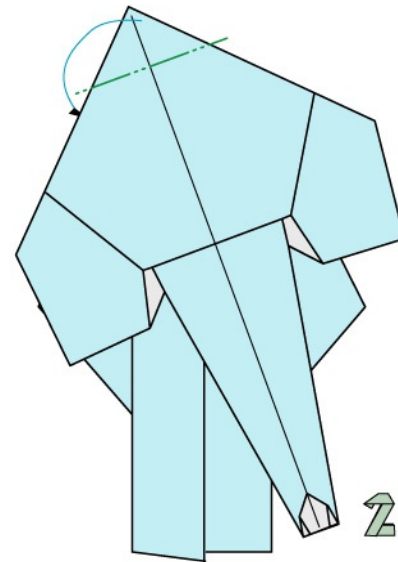

Con una piega a monte bloccate l'unione

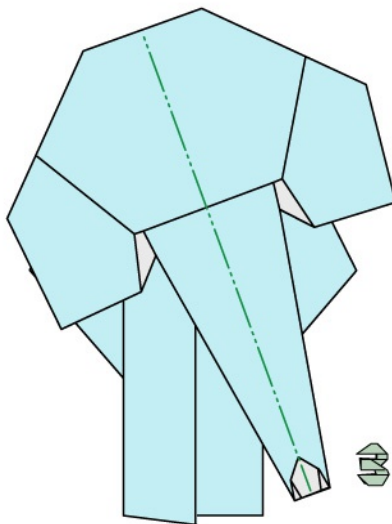

Ripiegate a monte

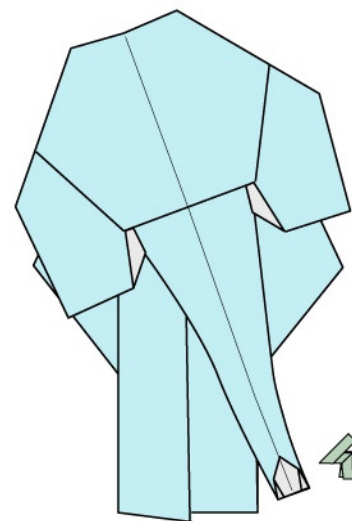

Elefantino ultimato

LEONCINO



Adoperate 2 fogli uguali quadrati bicolori, 1 per la costruzione della testa ed 1 per la costruzione del corpo, che si uniscono mediante un idoneo bloccaggio.

COSTRUZIONE DELLA TESTA

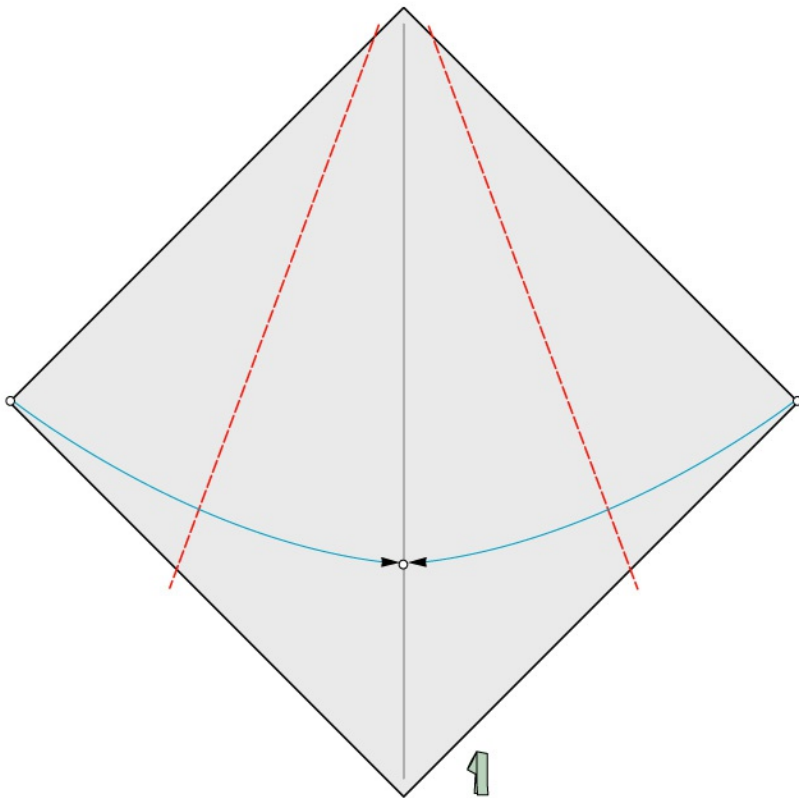

2 pieghe a valle

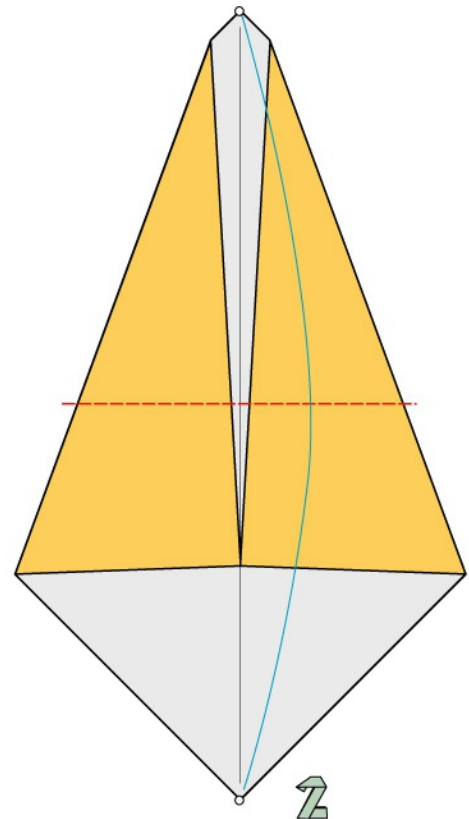

1 piega a valle

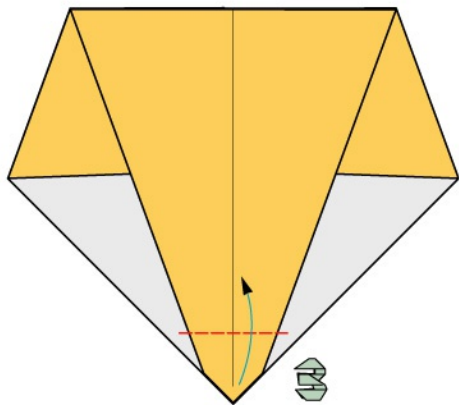

1 piega a valle

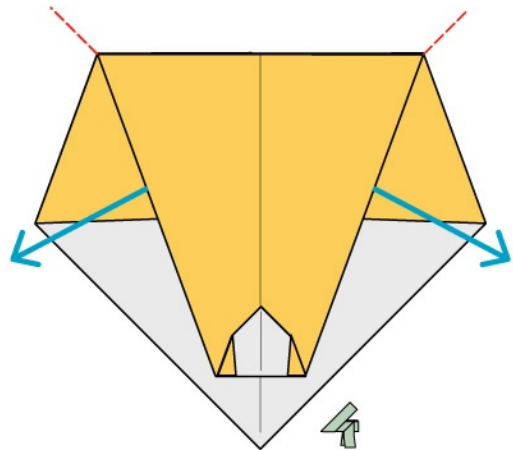

Estraete

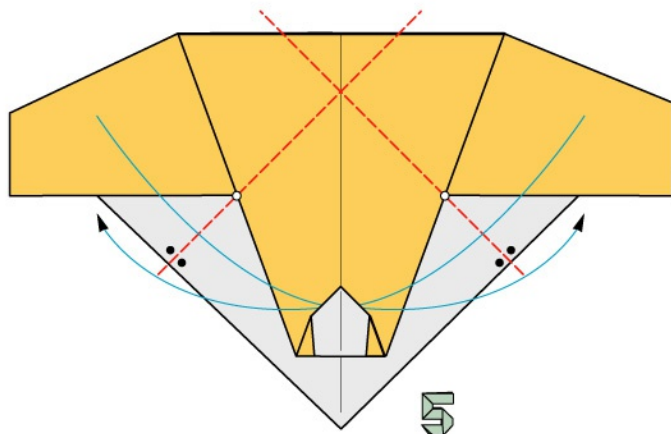

2 pieghe bisettrici a valle

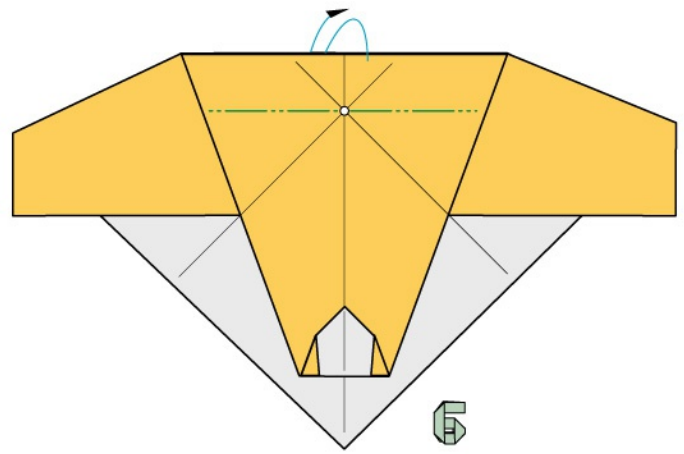

1 piega a monte

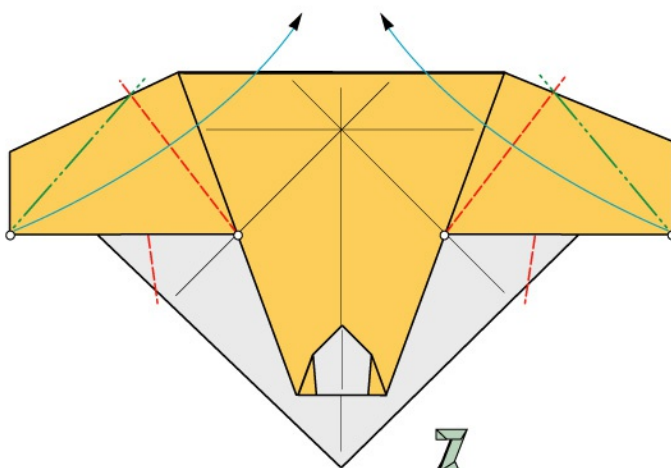

4 pieghe bisettrici a valle e 2 pieghe a monte

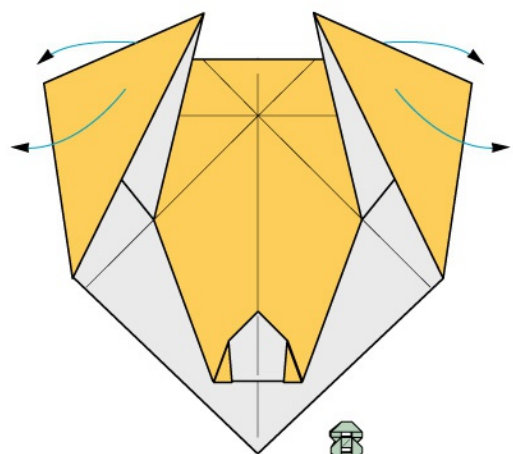

2 pieghe rovesce esterne

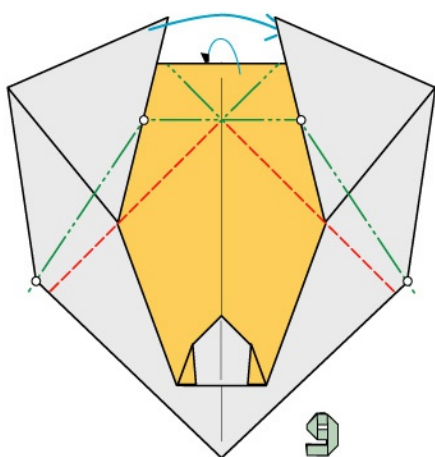

2 pieghe a monte e ripiegate

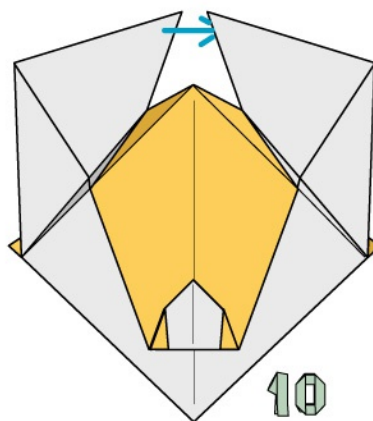

Inserite un'aletta entro l'altra

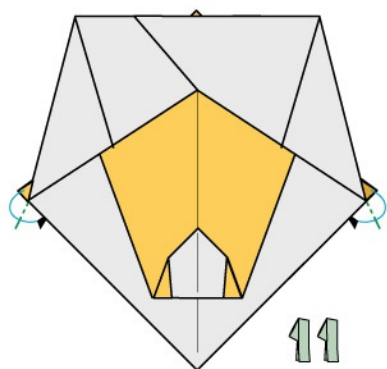

2 pieghe a monte

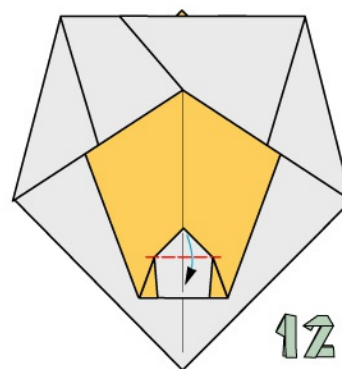

1 piega a valle

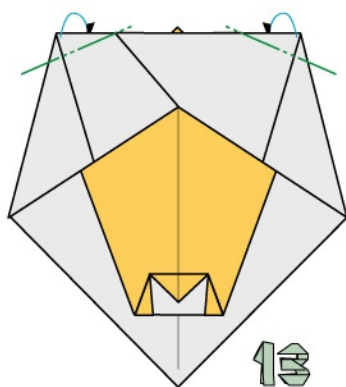

2 pieghe a monte

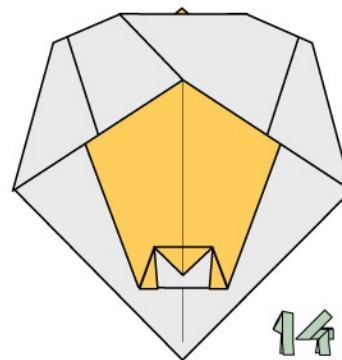

Testa ultimata

COSTRUZIONE DEL CORPO

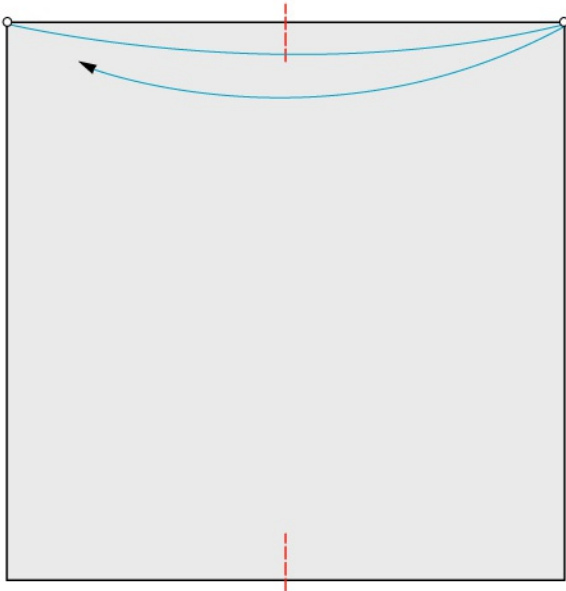

2 piccole pieghe a valle

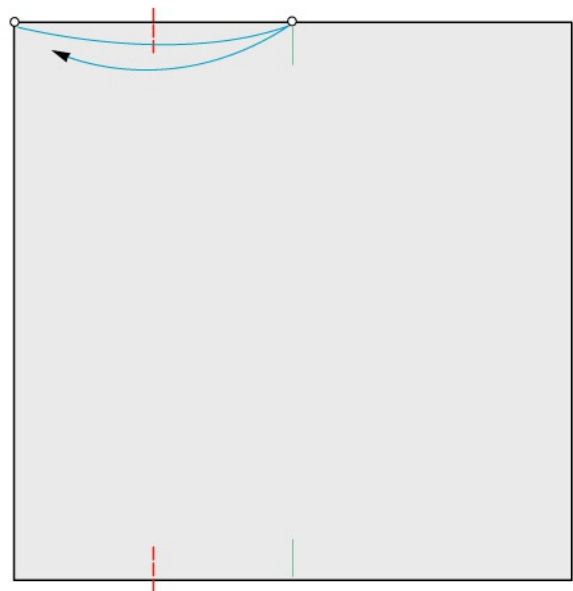

2 piccole pieghe a valle



1 piega a monte

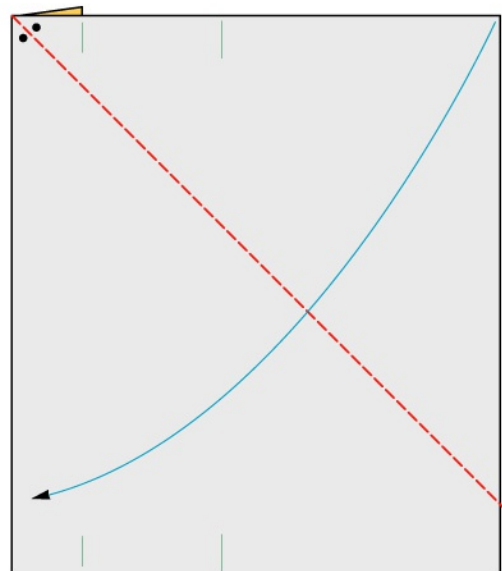

1 piega bisettrice a valle

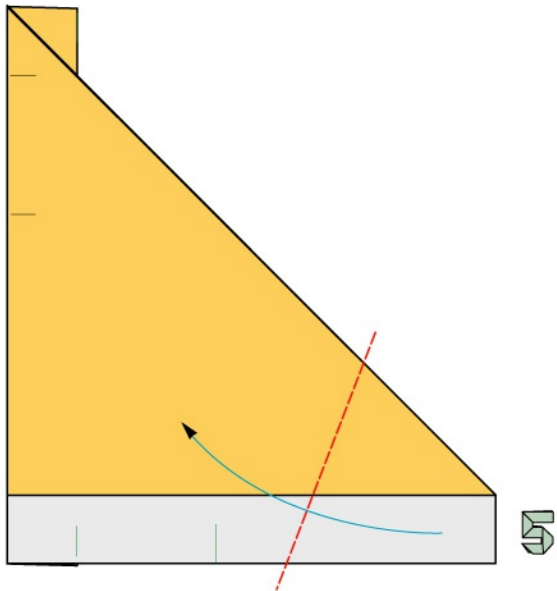

1 piega a valle

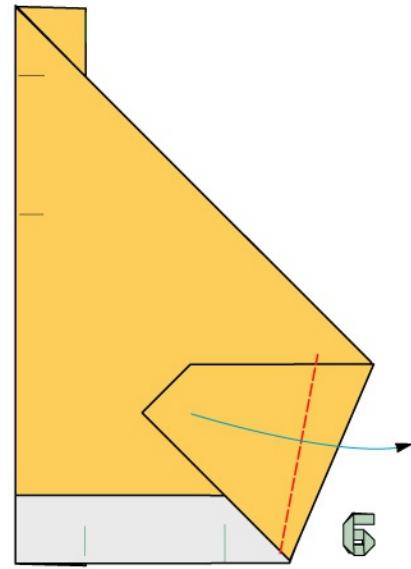

1 piega a valle

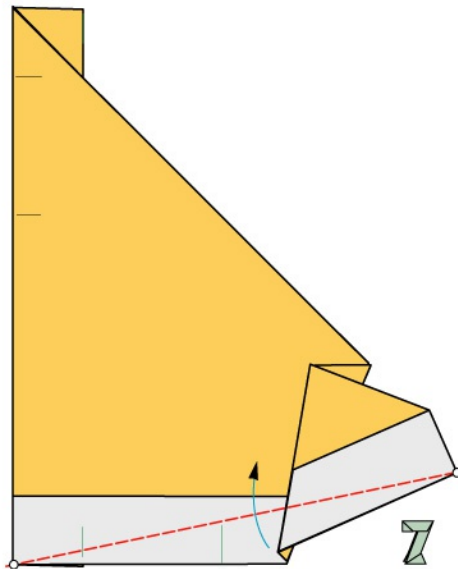

1 piega a valle

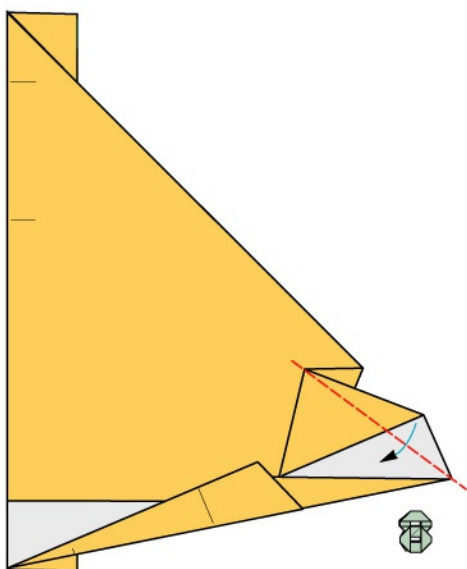

1 piega a valle

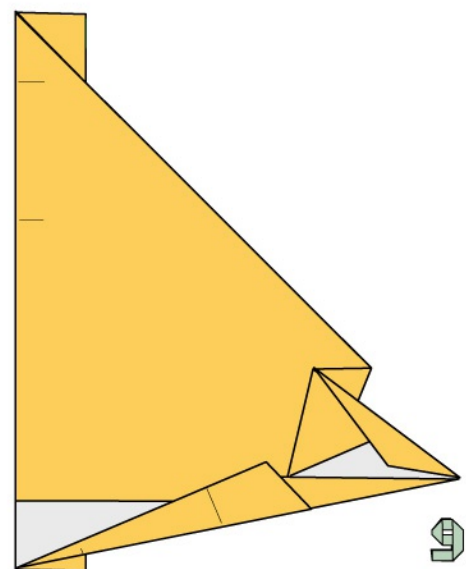

Retro del corpo ultimato

UNIONE DELLA TESTA CON IL CORPO

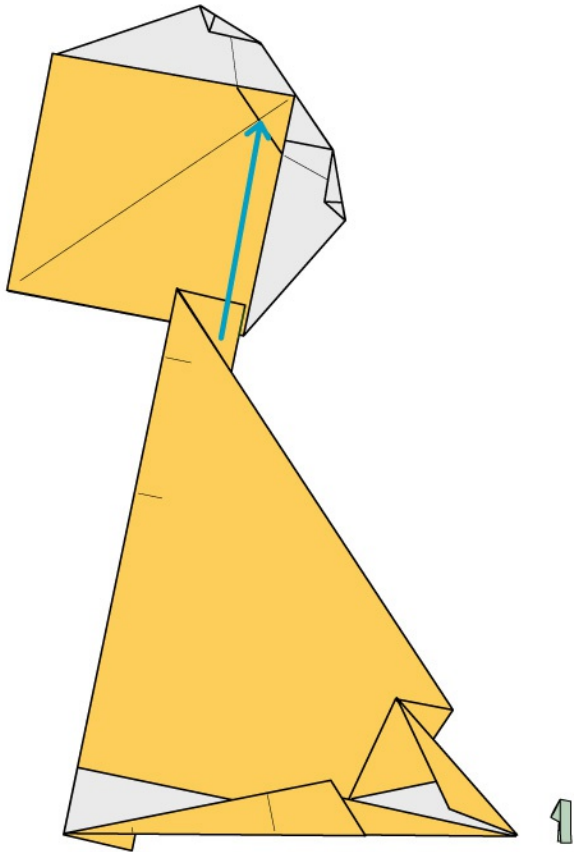

Inserite il corpo nella tasca del retro della testa

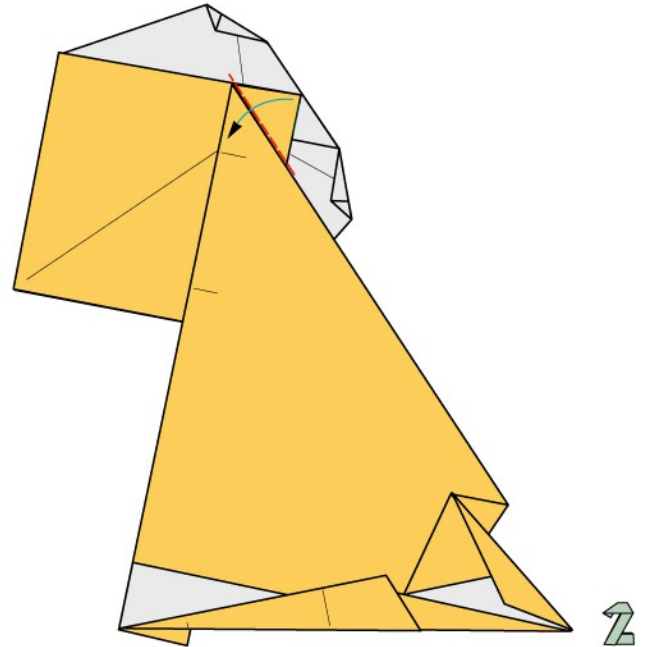

Con una piega a valle bloccate l'unione

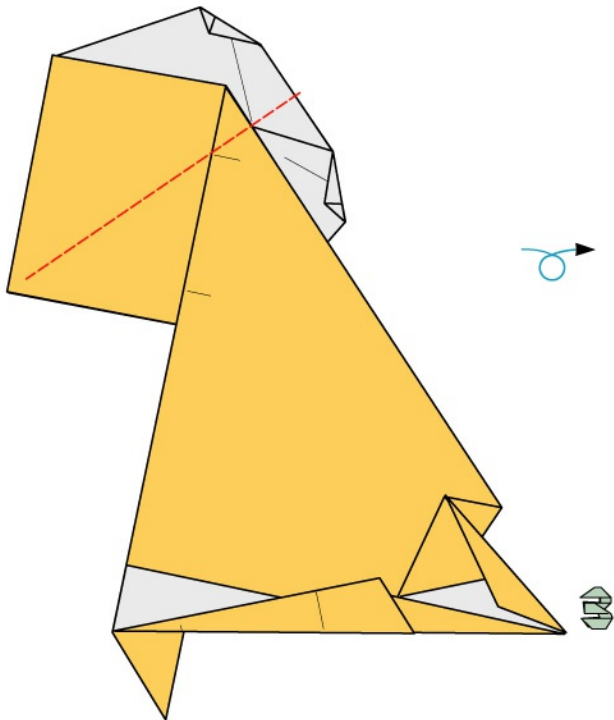

Ripiegate a valle e ribaltate

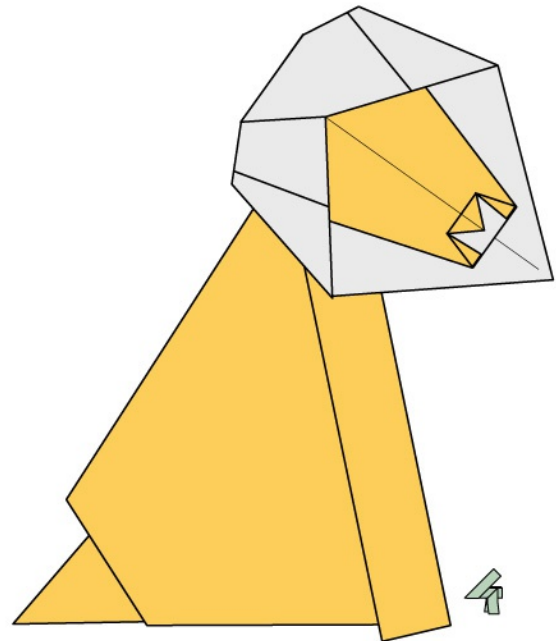

Leoncino ultimato

SCIMMIETTA



Adoperate 2 fogli uguali quadrati bicolori, 1 per la costruzione della testa ed 1 per la costruzione del corpo, che si uniscono mediante un idoneo bloccaggio.

COSTRUZIONE DELLA TESTA

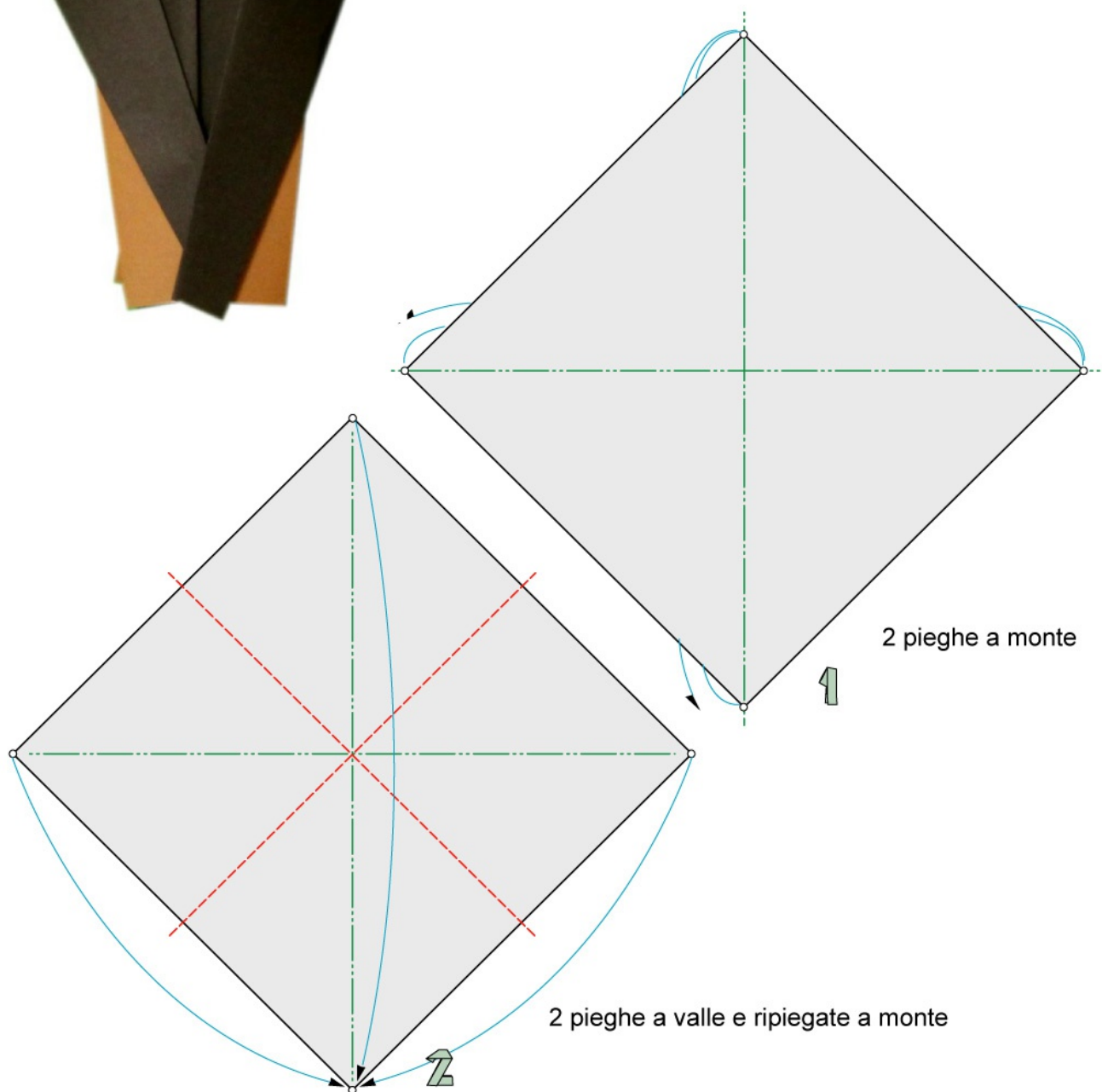

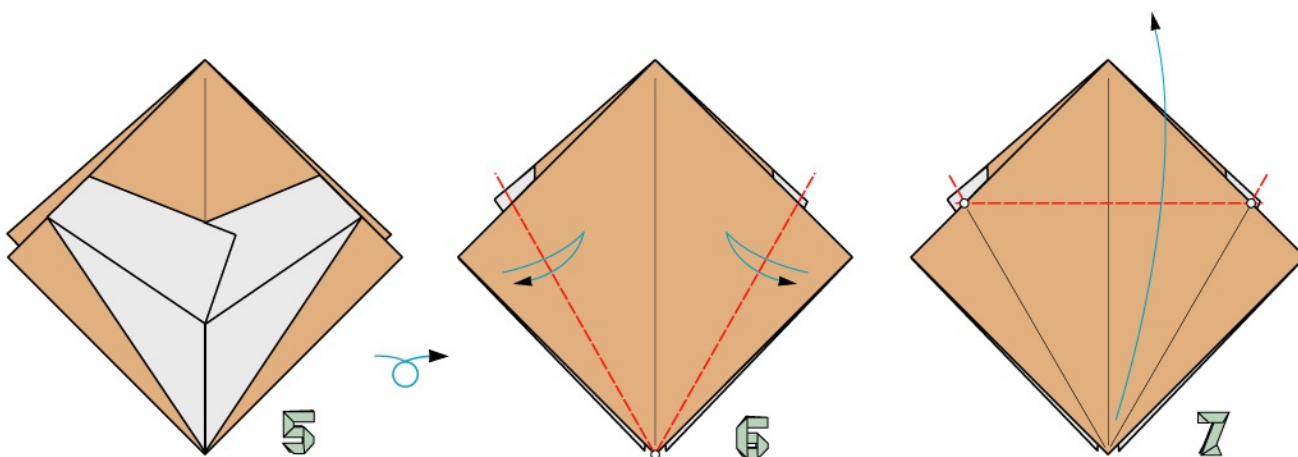
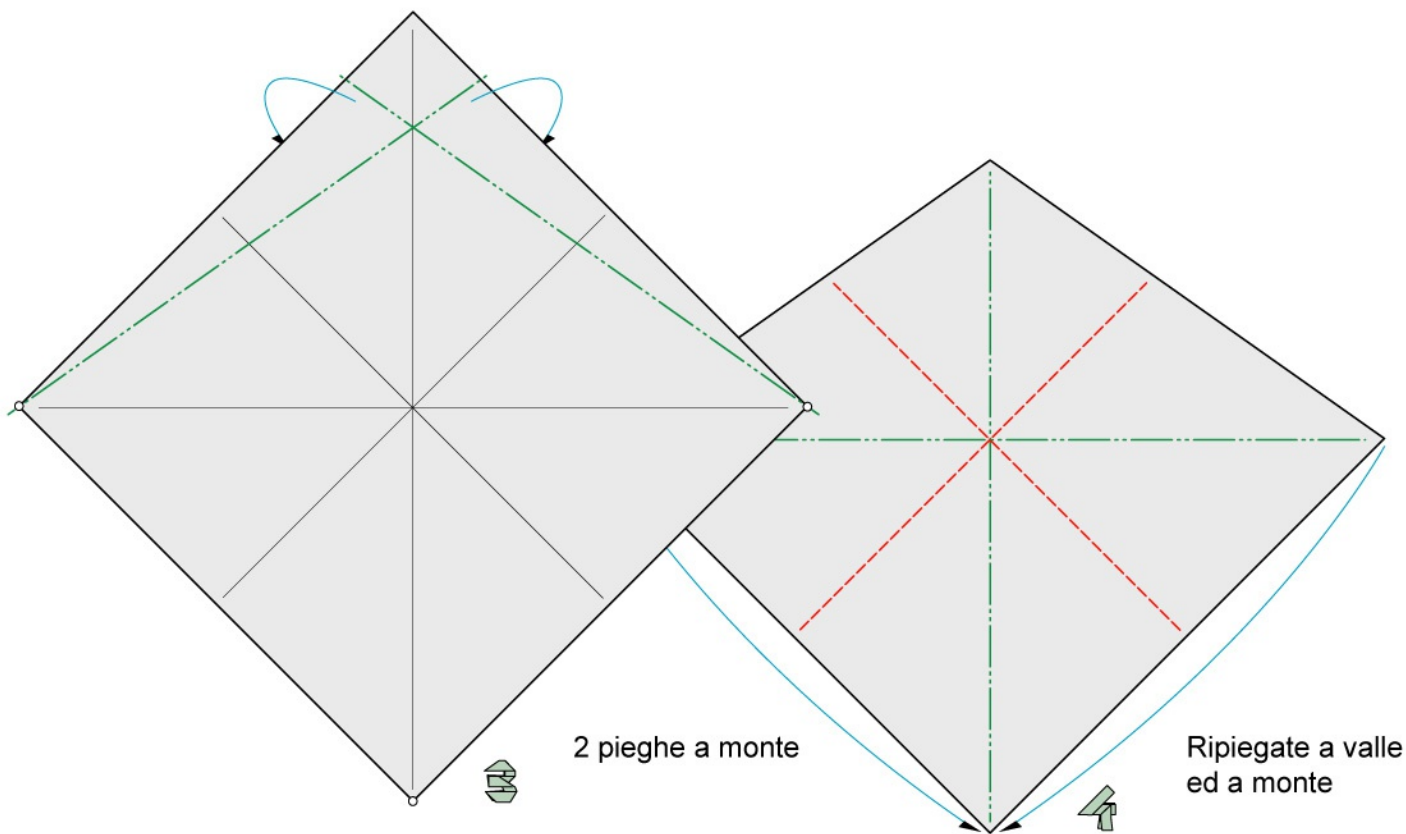

Ribaltate

2 pieghe a valle

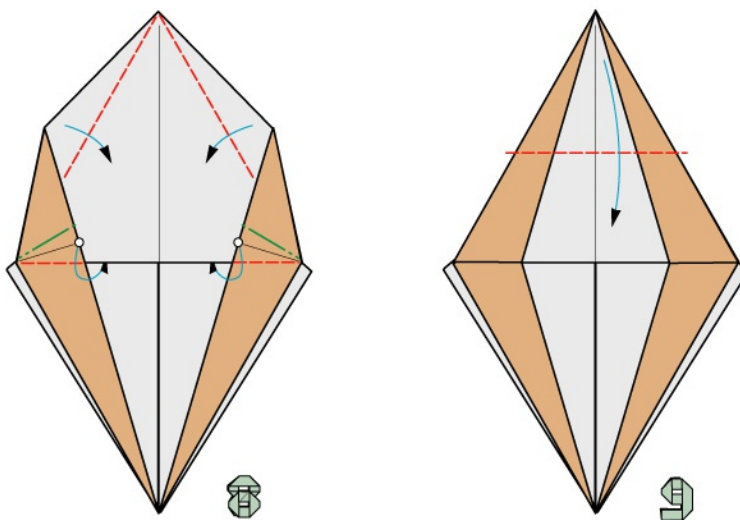

4 pieghe a valle, 2 a monte ed intascate

1 piega a valle

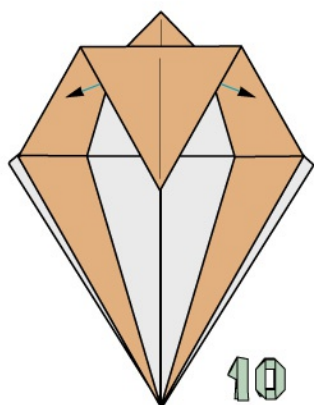

10

Estraete le 2 alette

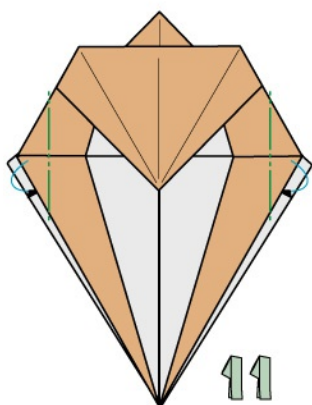

11

2 pieghe a monte

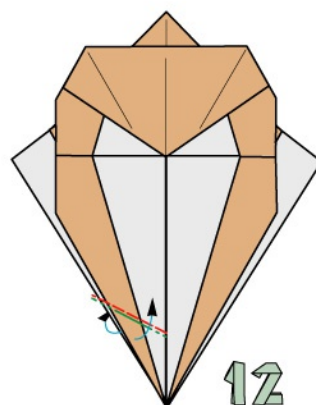

12

1 piega rovescia esterna

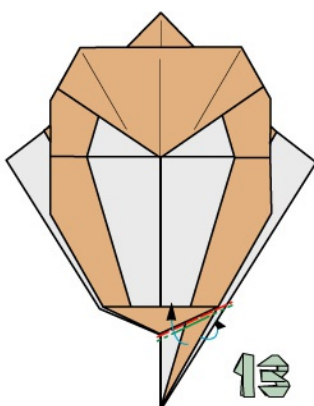

13

1 piega rovescia esterna

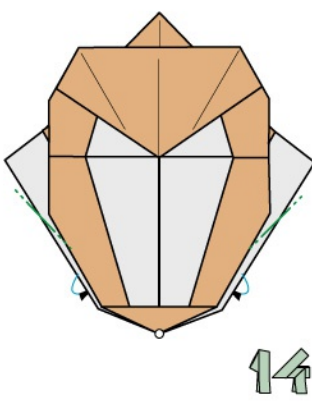

14

2 pieghe a monte

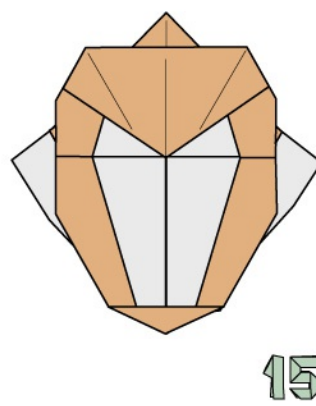

15

Testa ultimata

COSTRUZIONE DEL CORPO

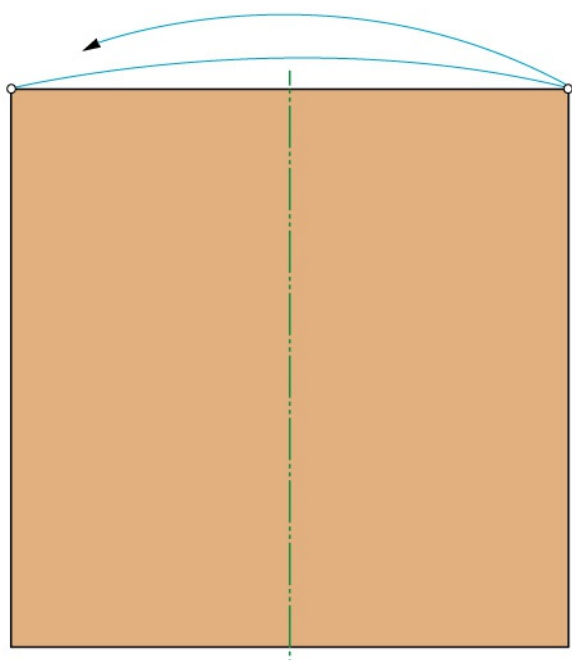

1

1 piega a monte

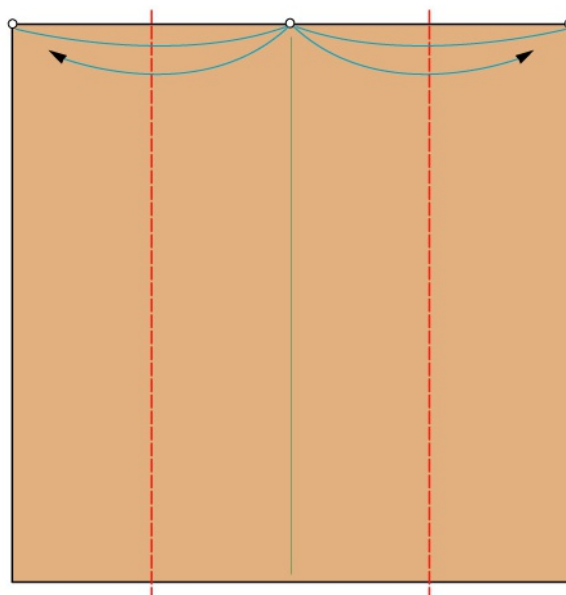

2

2 pieghe a valle

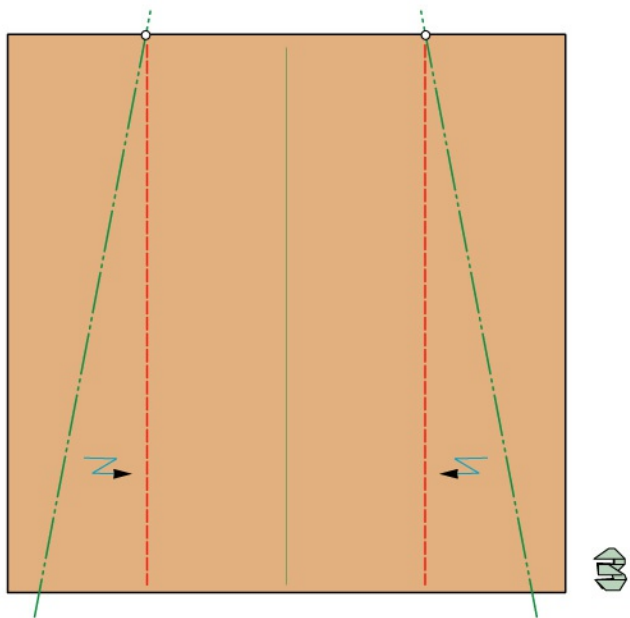

2 pieghe a monte e ripiegate a valle

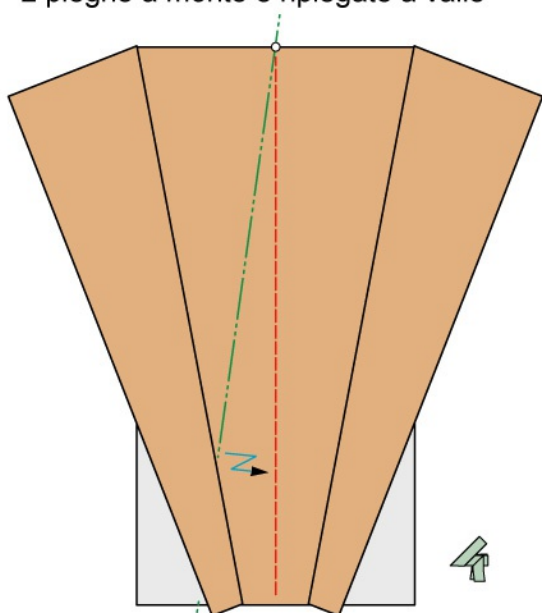

1 piega a monte e ripiegate a valle

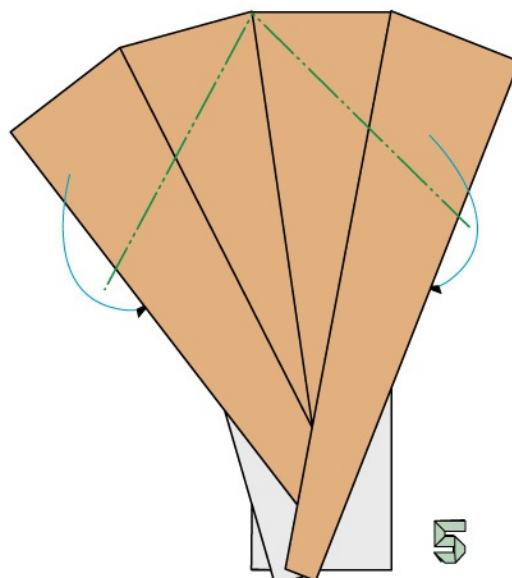

2 pieghe a monte

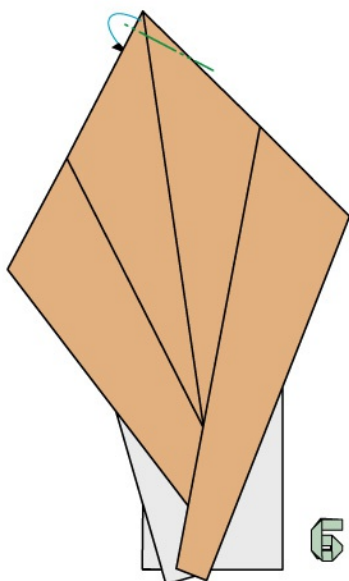

1 piega a monte

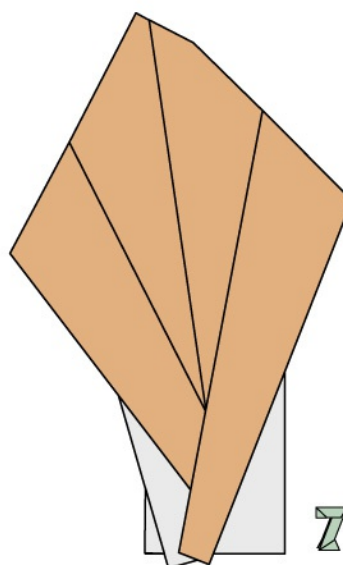

Corpo ultimato

UNIONE DELLA TESTA CON IL CORPO

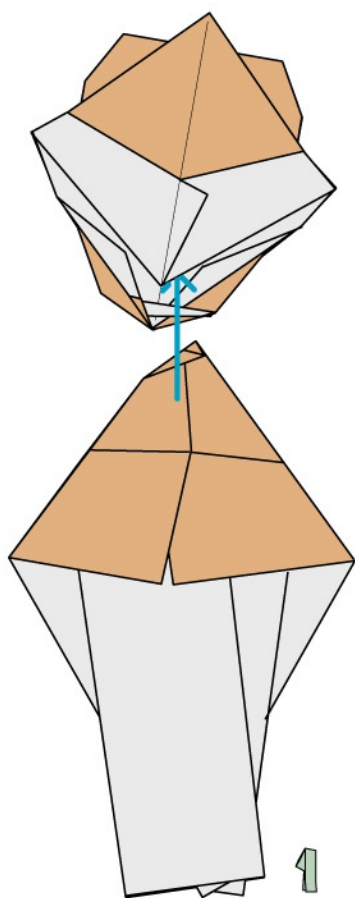

Inserite il corpo nella tasca della testa

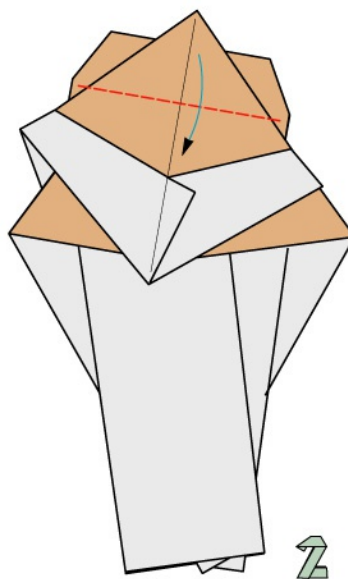

Con una piega a valle bloccate l'unione

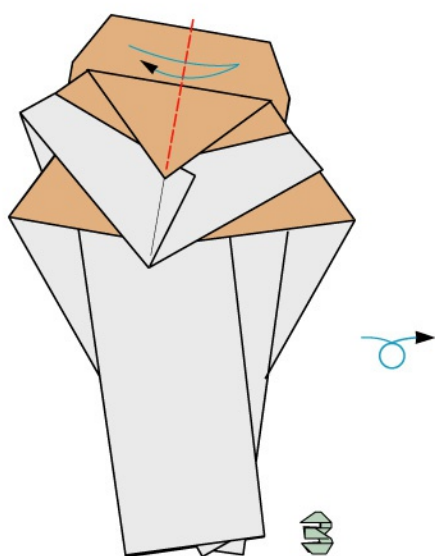

Ripiegate a valle e ribaltate

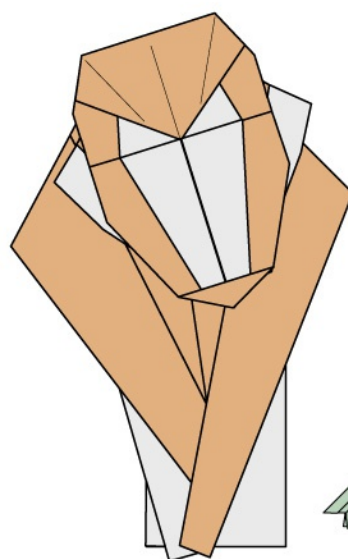

Scimmietta ultimata

PANDA



Adoperate 2 fogli uguali quadrati bicolori, 1 per la costruzione della testa ed 1 per la costruzione del corpo, che si uniscono mediante un idoneo bloccaggio.

COSTRUZIONE DELLA TESTA

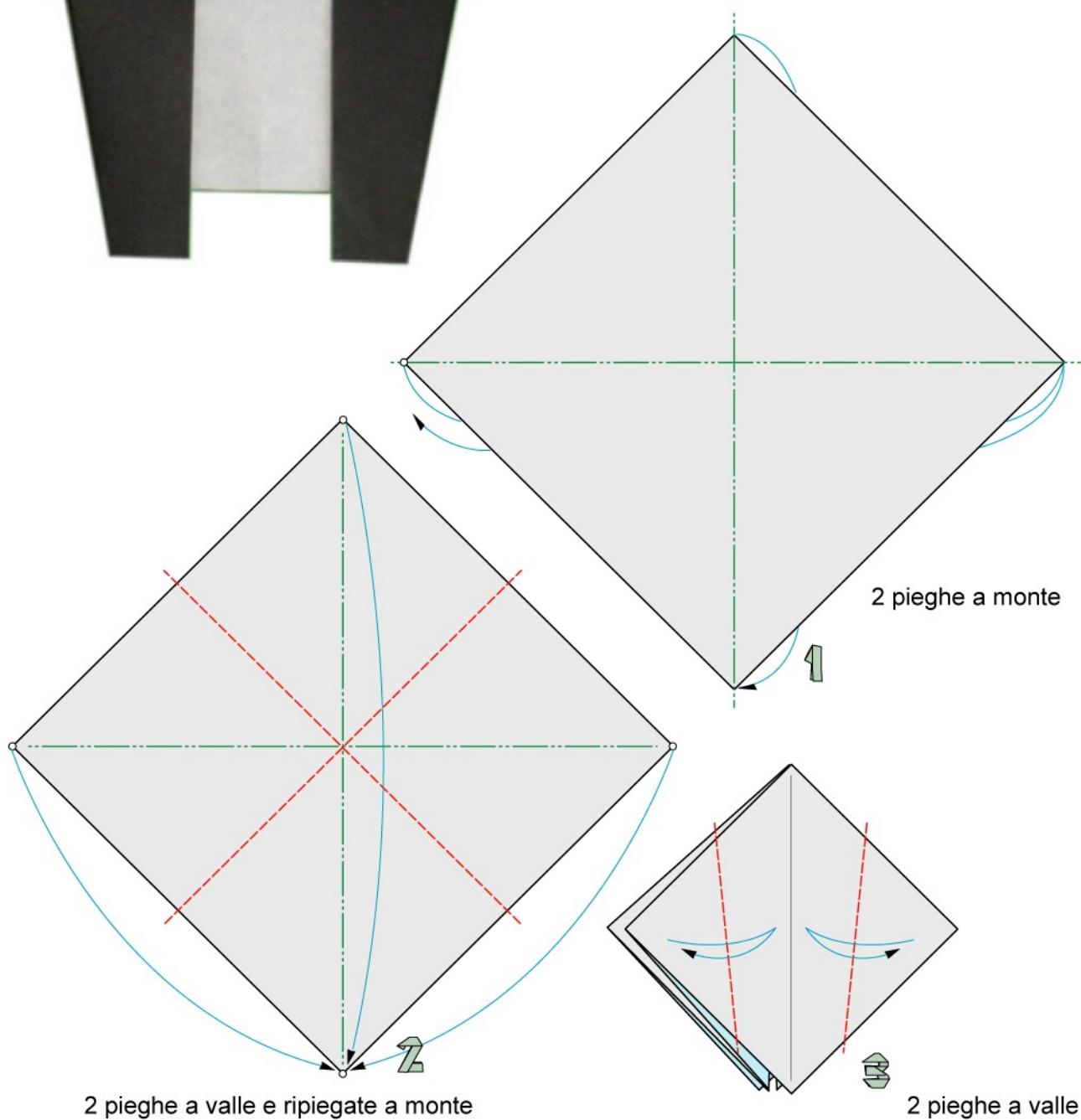

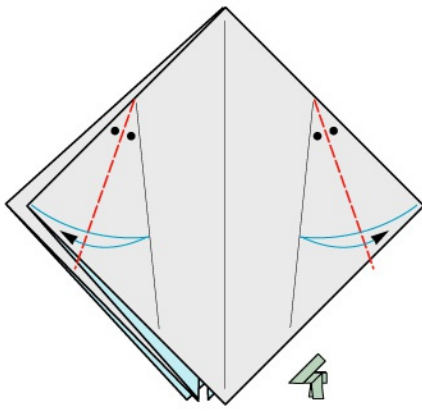

2 pieghe bisettrici a valle

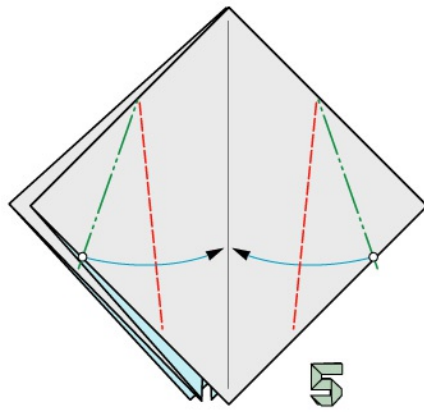

2 pieghe a monte e ripiegate a valle

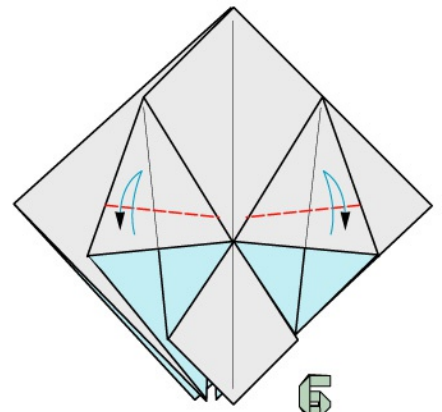

2 pieghe a valle

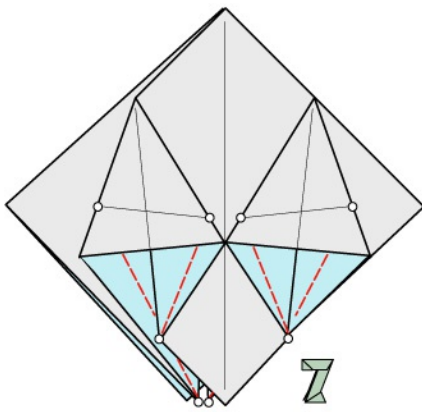

4 pieghe a valle

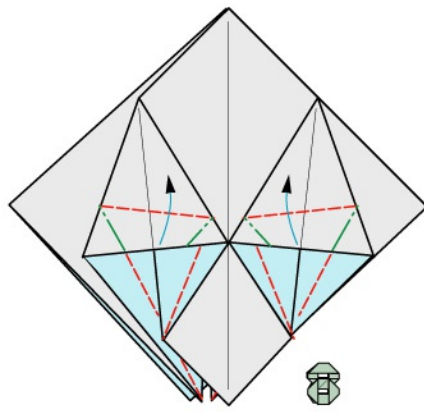

4 pieghe a monte e ripiegate a valle

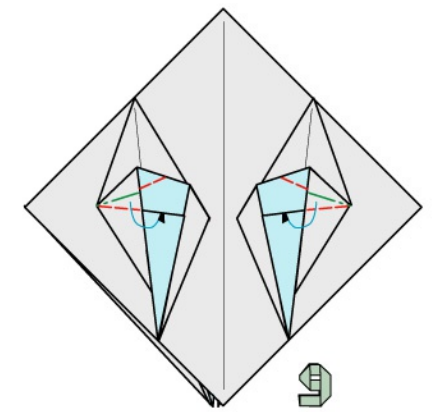

4 pieghe a valle, 2 a monte ed intascate

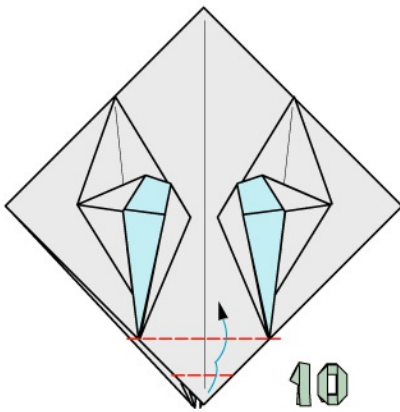

2 pieghe a valle

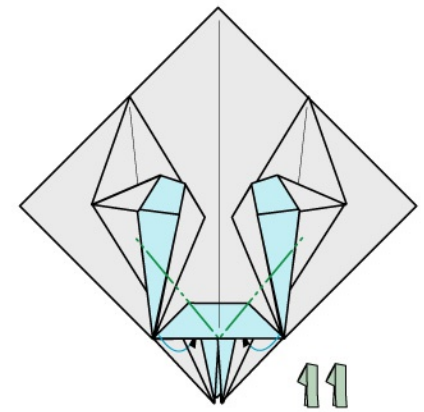

2 pieghe a monte

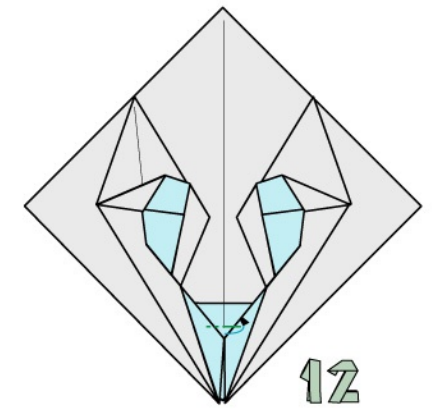

1 piccola piega a monte

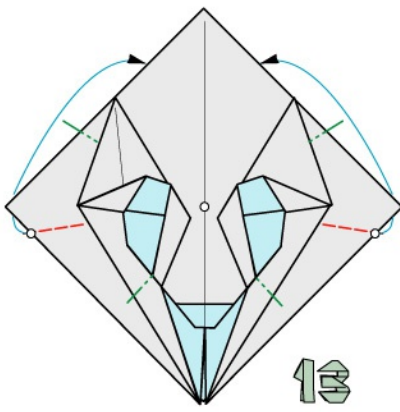

2 pieghe a valle e 4 a monte

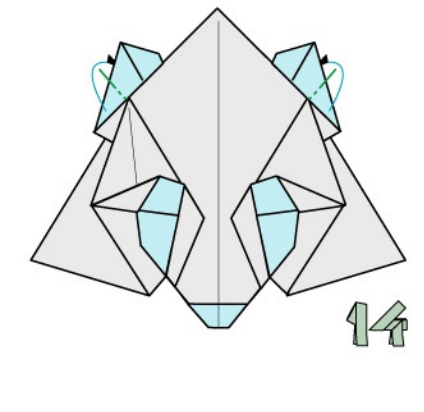

2 pieghe a monte

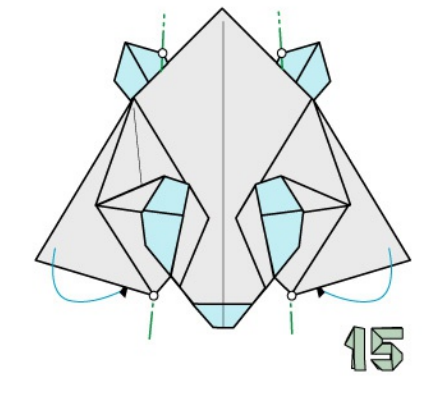

2 pieghe a monte

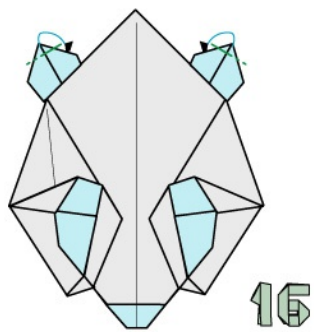

2 pieghe a monte

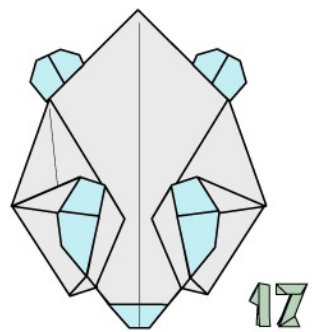

Testa ultimata

COSTRUZIONE DEL CORPO

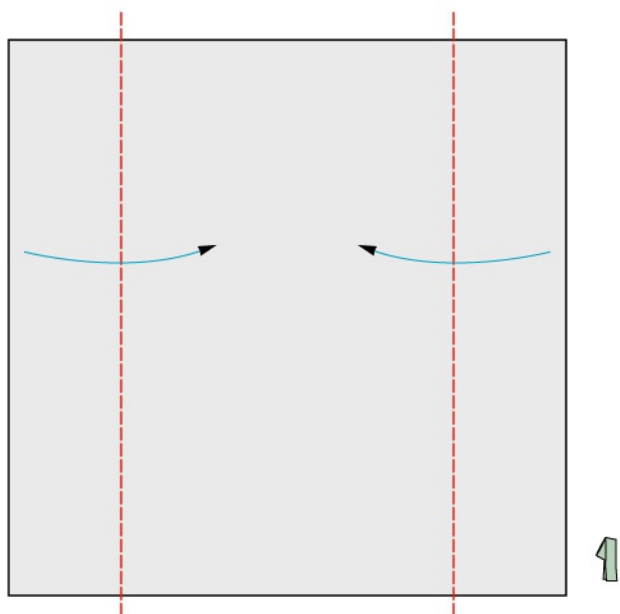

2 pieghe a valle

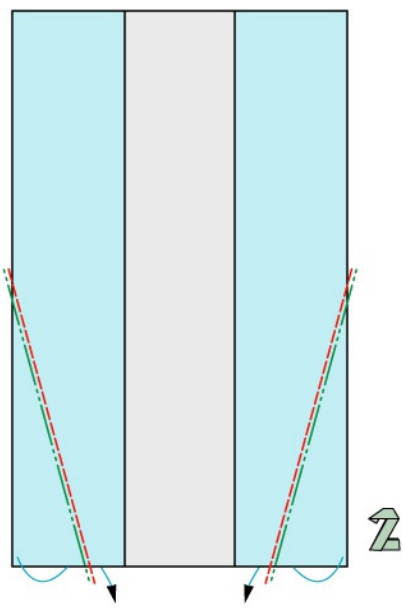

2 pieghe rovesce interne

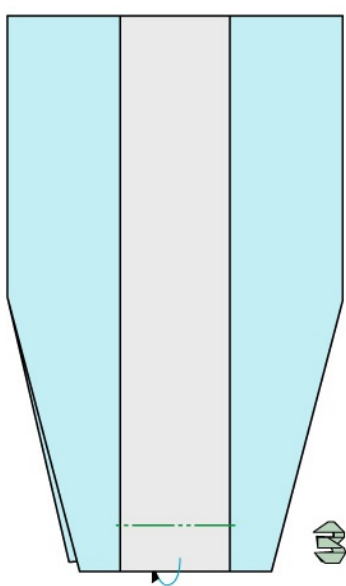

1 piega a monte

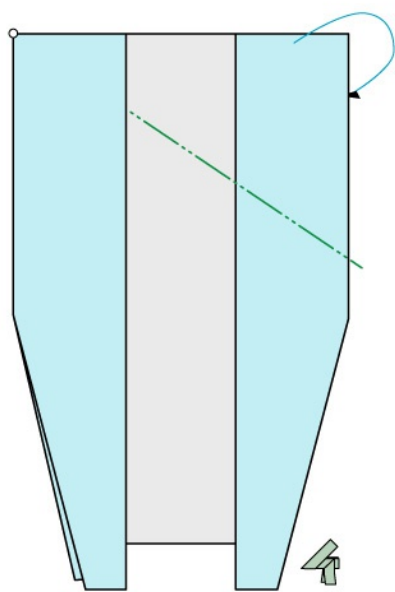

1 piega a monte

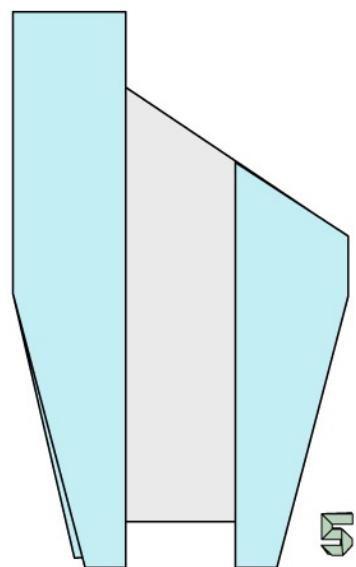

Corpo ultimato

UNIONE DELLA TESTA CON IL CORPO

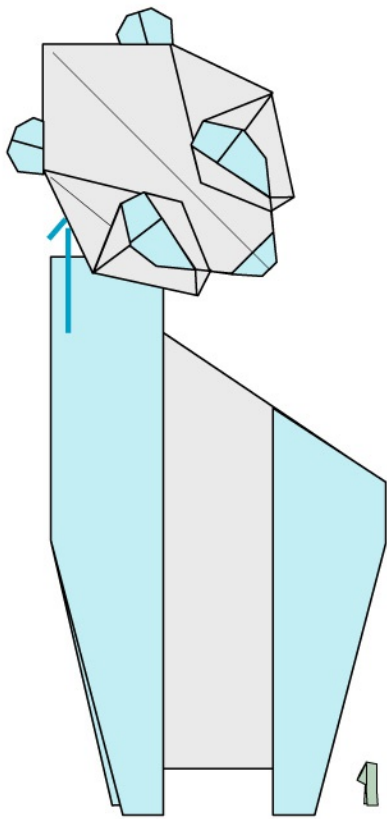

Inserite il corpo nella tasca della testa

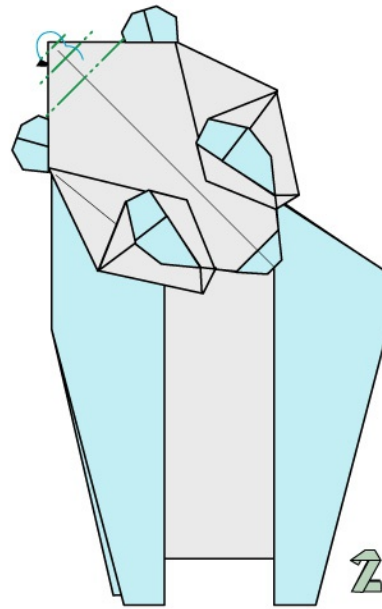

Con 2 pieghe a monte bloccate l'unione

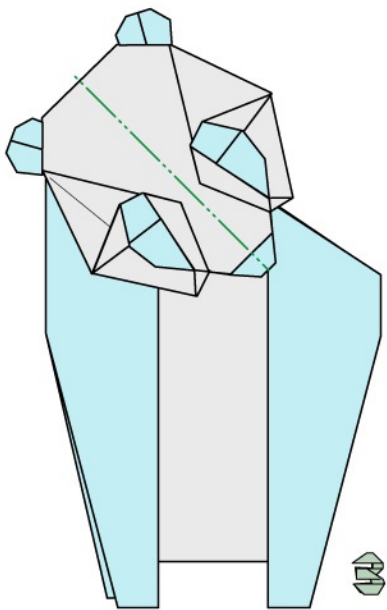

Ripiegate a monte

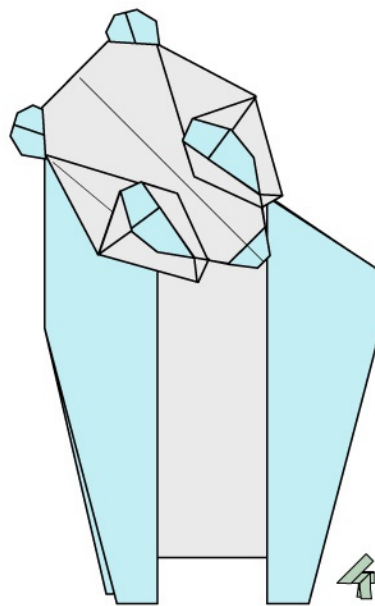

Orsetto ultimato

DRAGHETTO

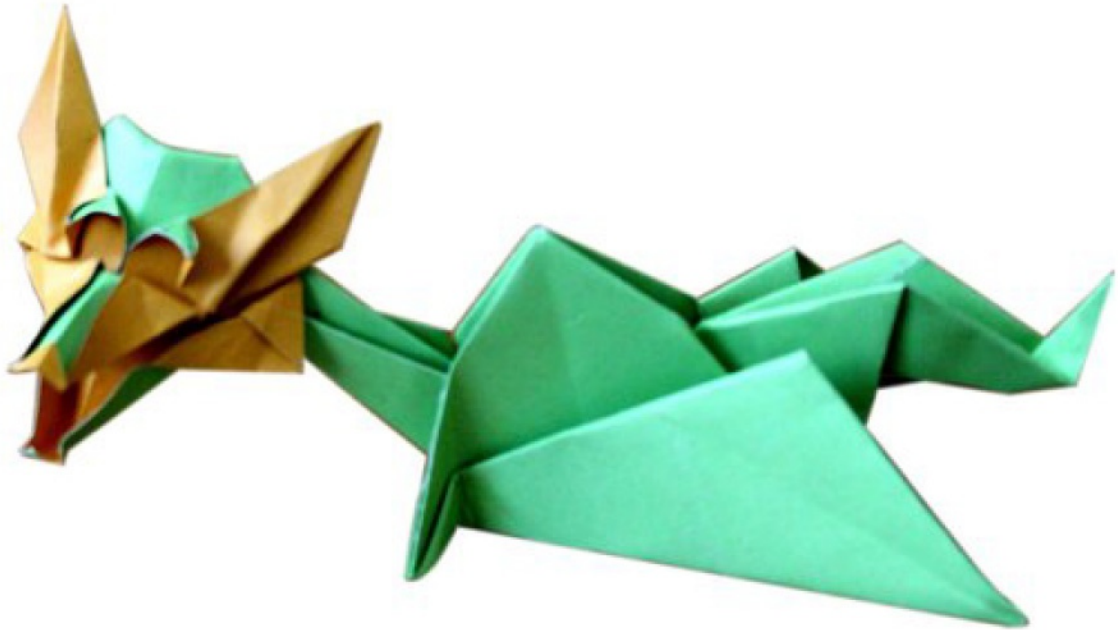

Adoperate 2 fogli quadrati bicolori, 1 di dimensioni doppie dell'altro, 1 per la costruzione della testa ed 1 per la costruzione del corpo, che si uniscono mediante un idoneo bloccaggio.

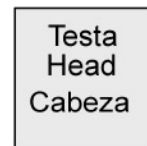
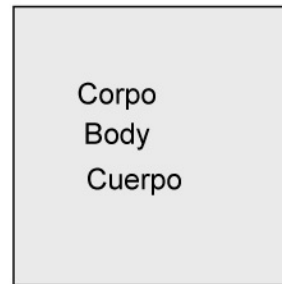

COSTRUZIONE DELLA TESTA

Partite dalla fig. n. 5 di "Gattino"

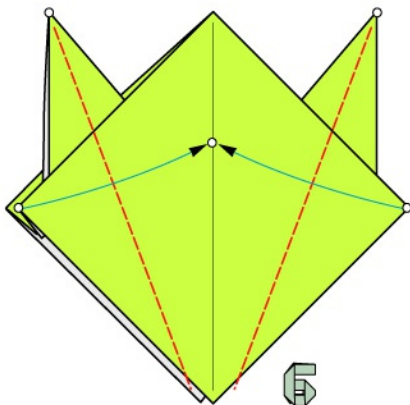

2 pieghe a valle

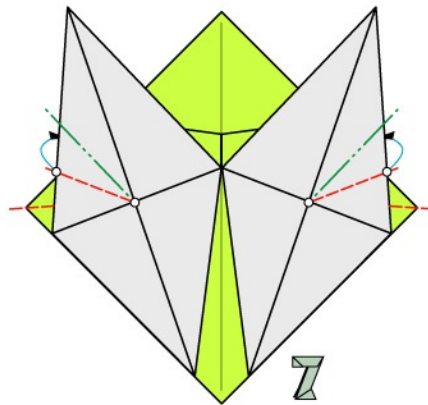

4 pieghe a valle e 2 a monte

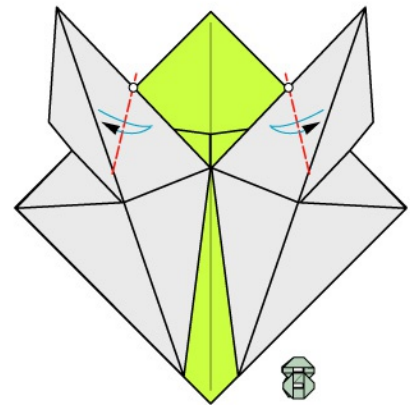

2 pieghe a valle per aprire le orecchie



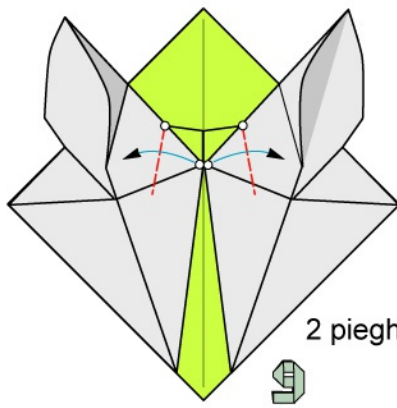

2 pieghe a valle

9

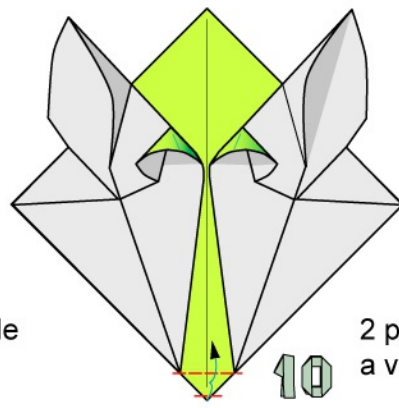

2 piccole pieghe a valle

10

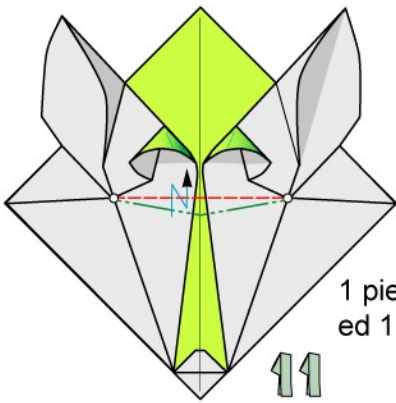

1 piega a valle ed 1 a monte

11

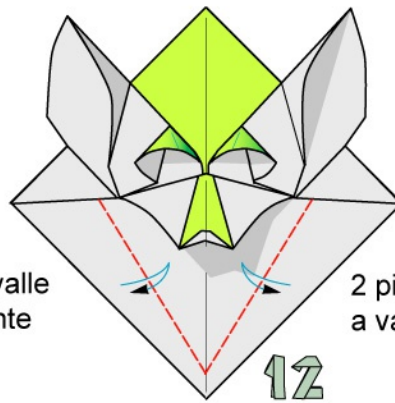

2 pieghe a valle

12

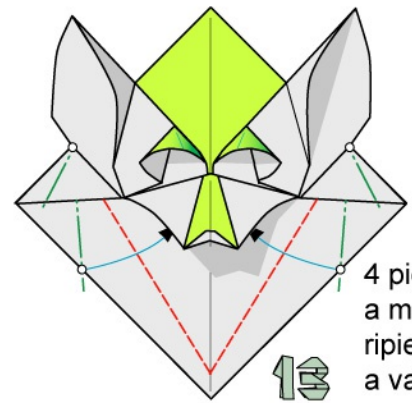

4 pieghe a monte e ripiegate a valle

13

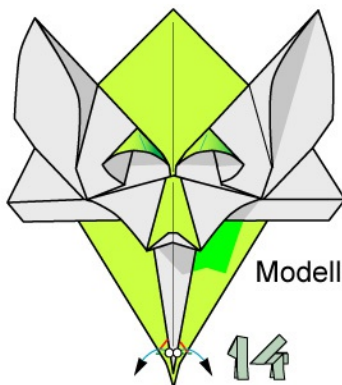

Modellate la bocca

14

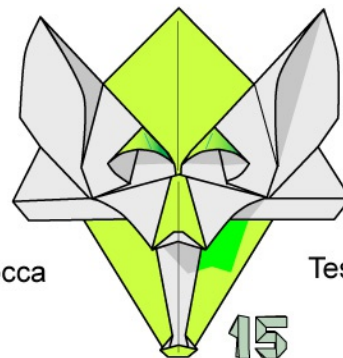

Testa ultimata

15

COSTRUZIONE DEL CORPO

Partite dalla fig. n. 2 di "Topolino"

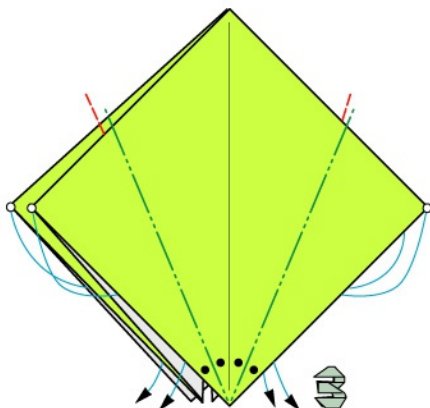

4 pieghe rovesce interne

3

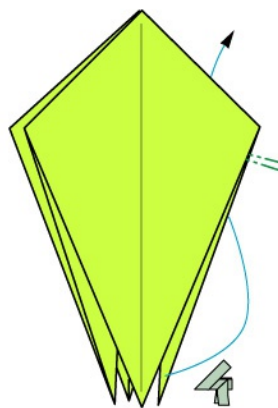

1 piega rovescia esterna

4

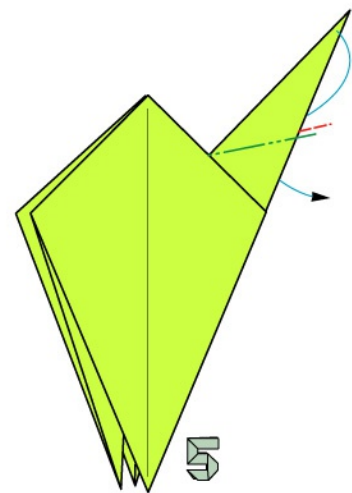

1 piega rovescia interna

5

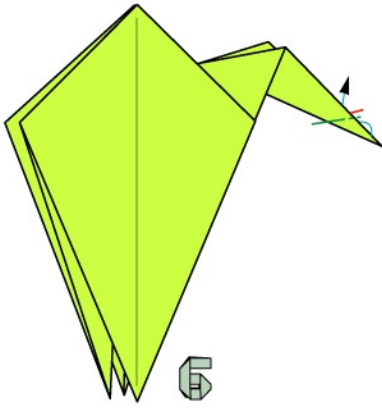

1 piega rovescia interna

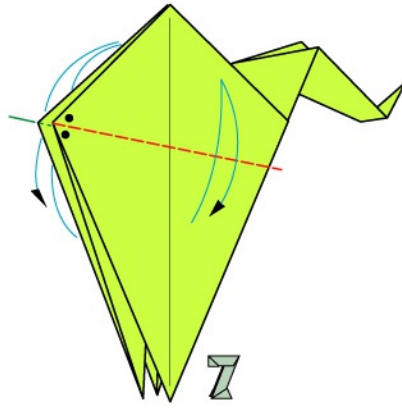

1 piega a valle per lato

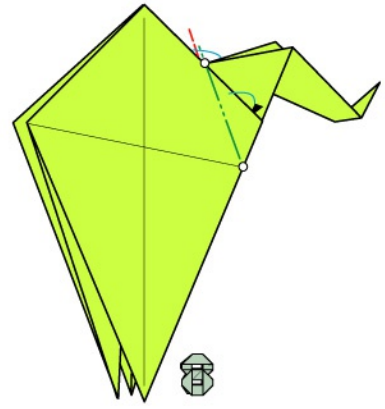

1 piega a monte per lato

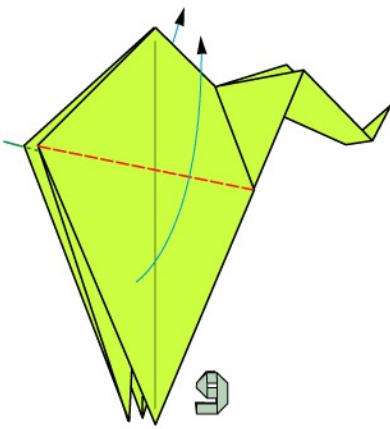

Ripiegate a valle

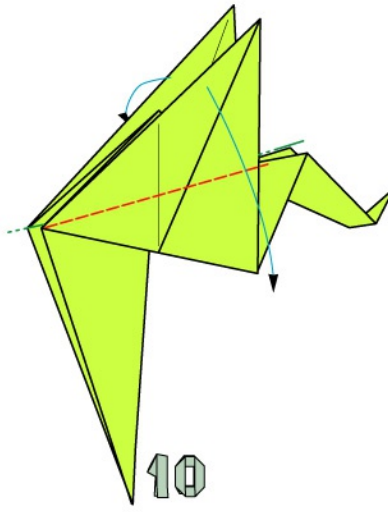

2 pieghe a valle

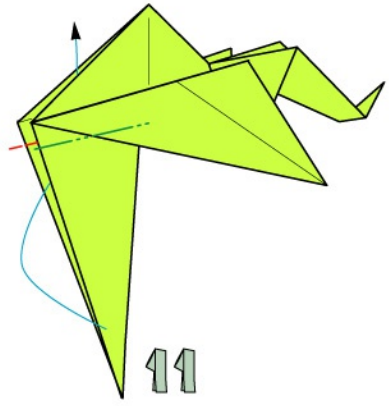

1 piega rovescia interna

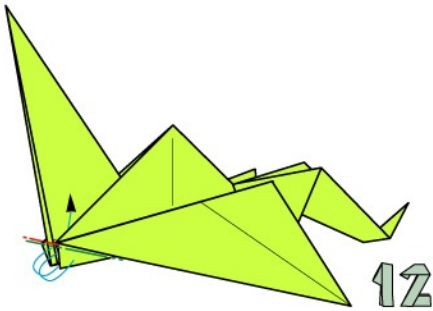

2 pieghe rovesce interne

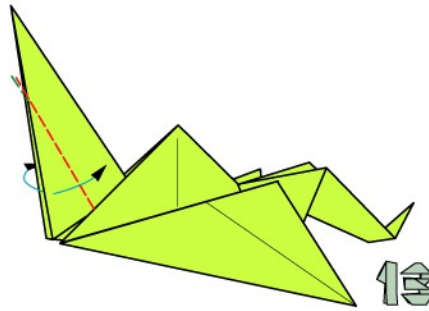

2 pieghe a valle

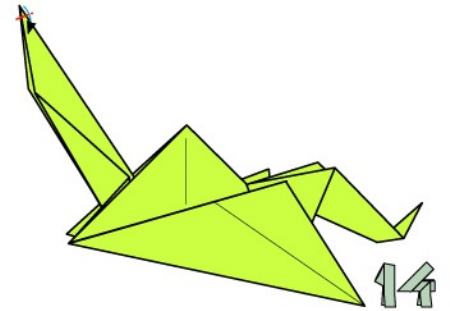

1 piega a valle

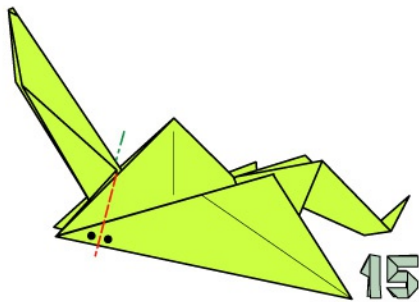

1 piega a valle per lato

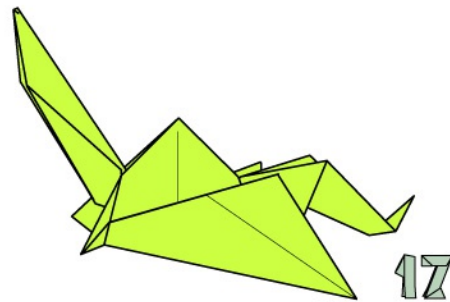

Corpo ultimato

UNIONE DELLA TESTA CON IL CORPO

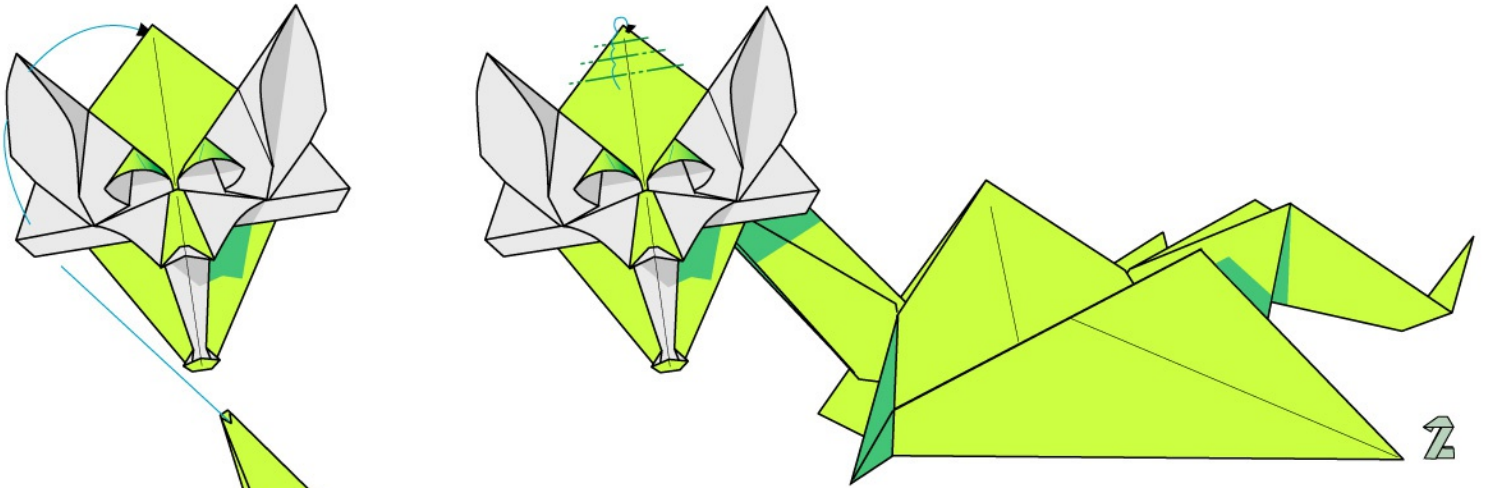

Con 3 pieghe a monte bloccate l'unione

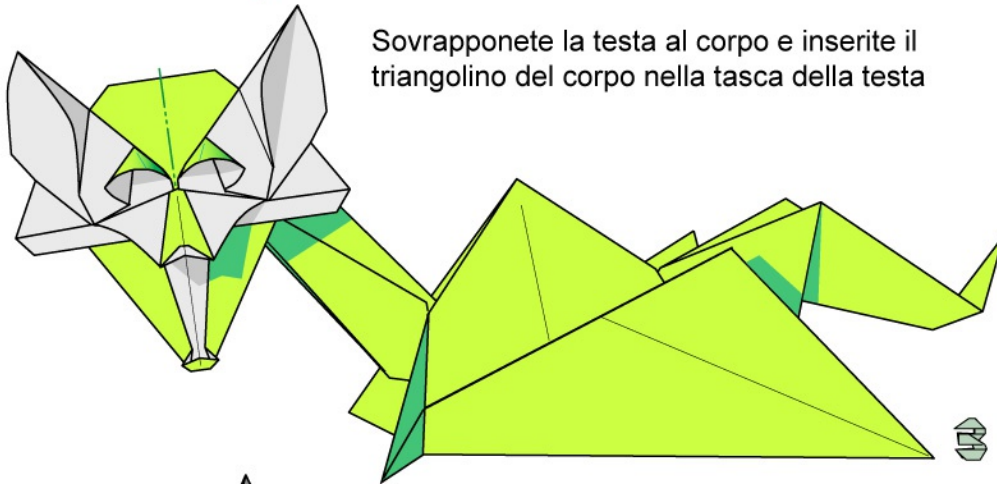
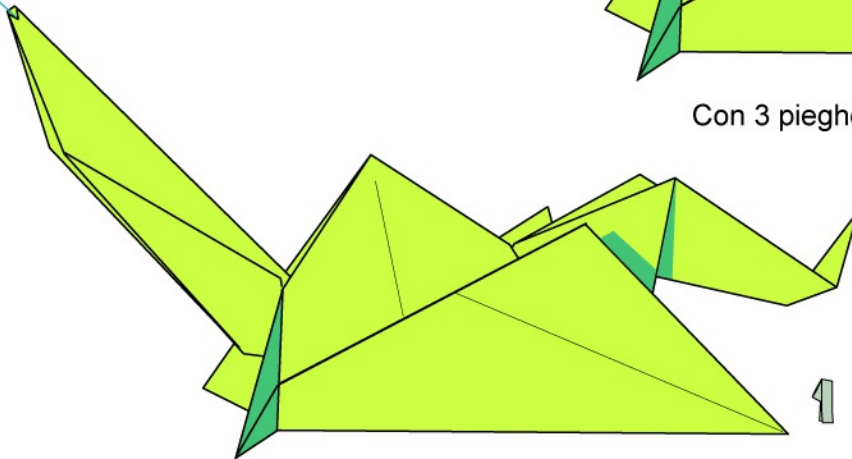

Sovrapponete la testa al corpo e inserite il triangolino del corpo nella tasca della testa

Ripiegate a monte

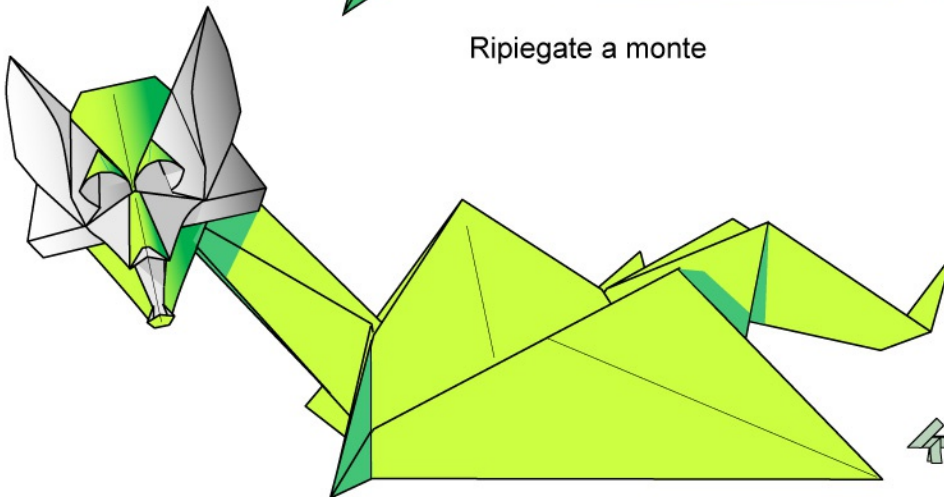

Draghetto ultimato



GUARDIANO

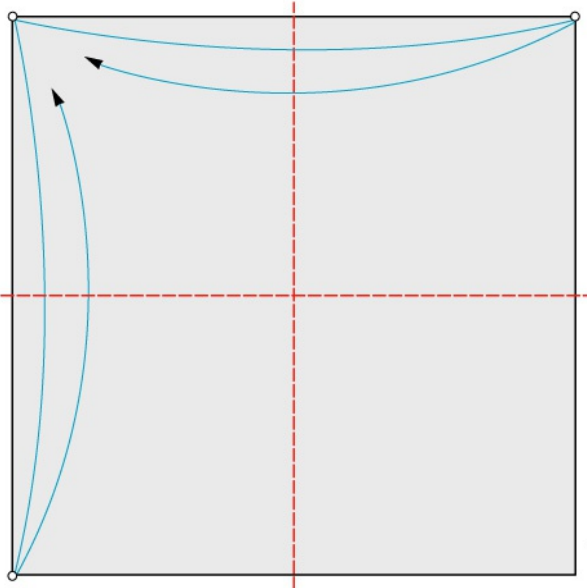

2 pieghe a valle

1

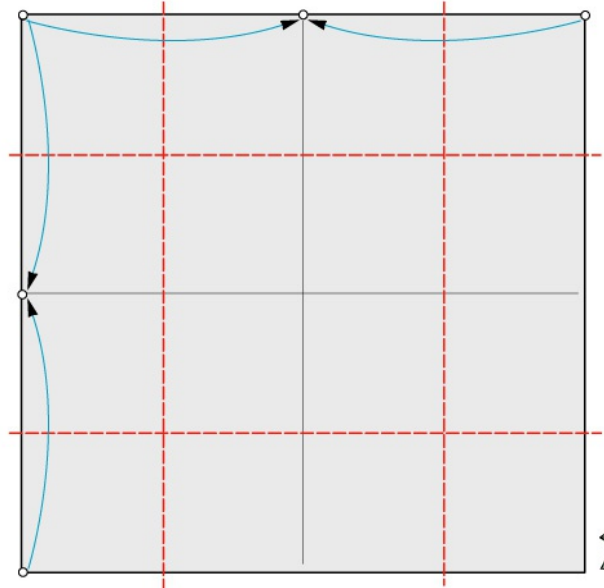

4 pieghe a valle

2

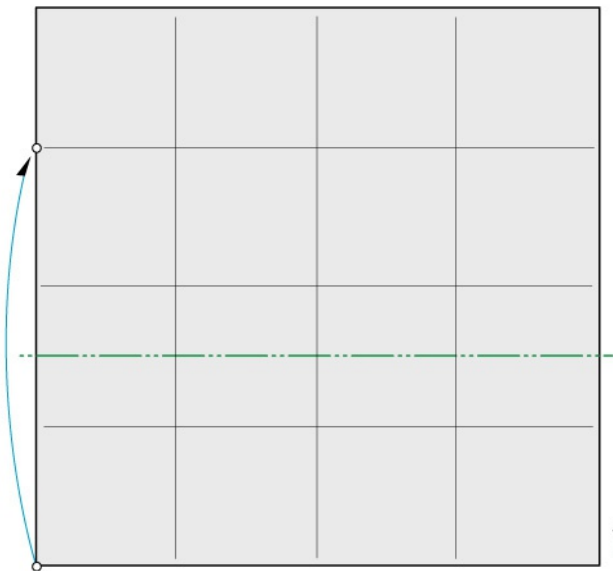

1 piega a monte

3

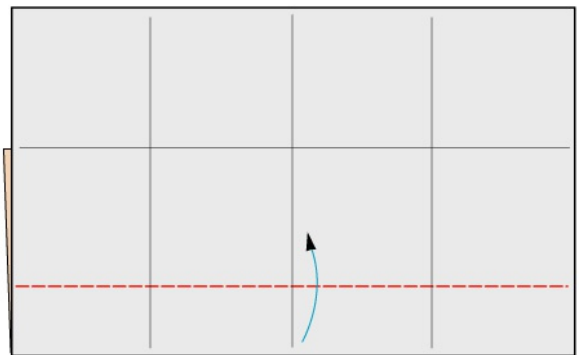

Ripiegate a valle

4

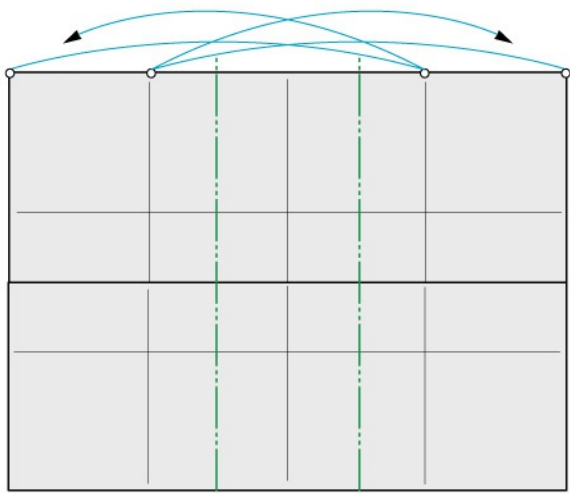

2 pieghe a monte

5

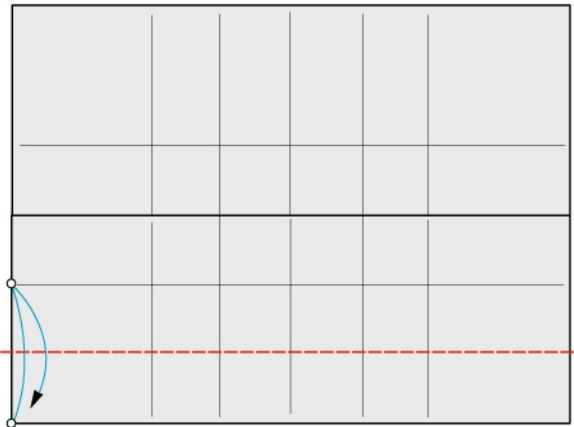

1 piega a valle

6

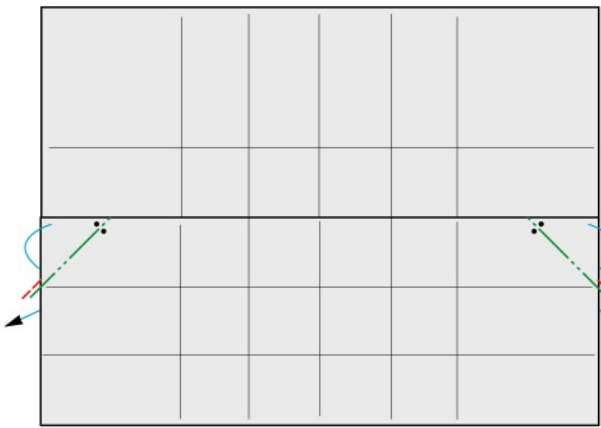

2 pieghe rovesce interne

7

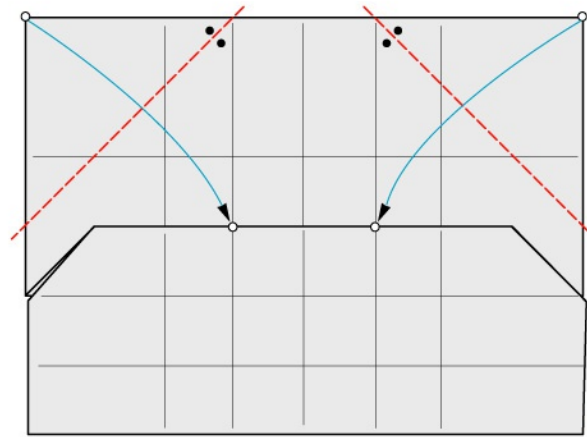

2 pieghe bisettrici a valle

8

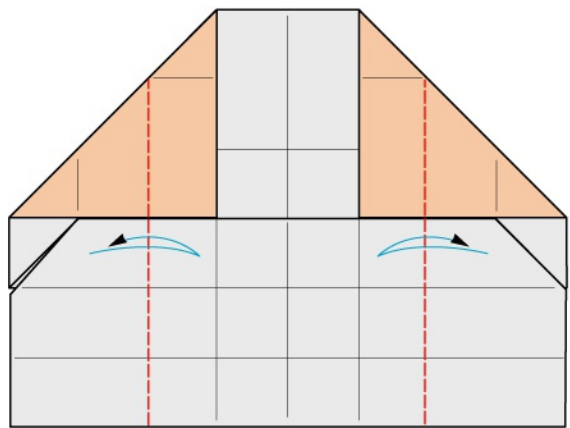

2 pieghe a valle

9

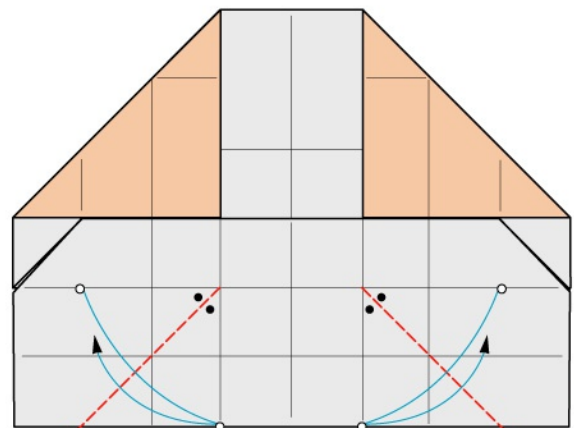

2 pieghe bisettrici a valle

10

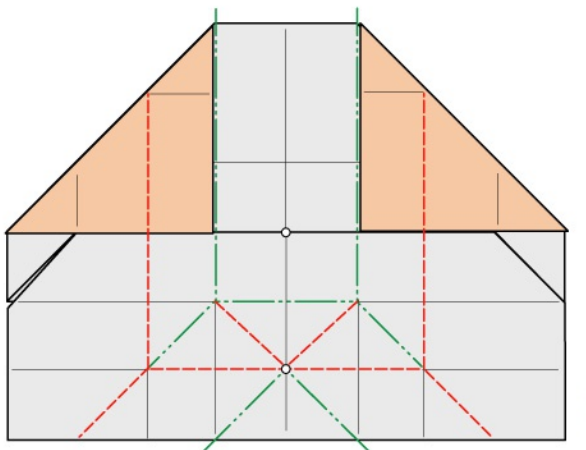

2 pieghe a valle, 2 a monte e ripiegate

11

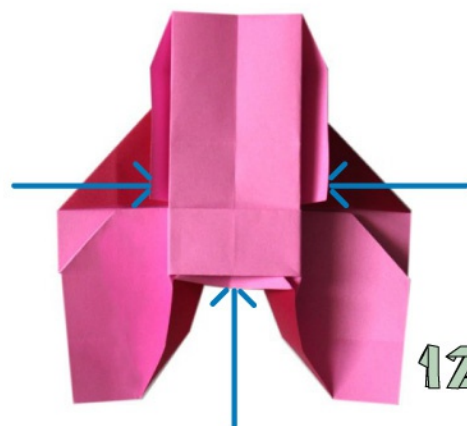

Fate rientrare

12

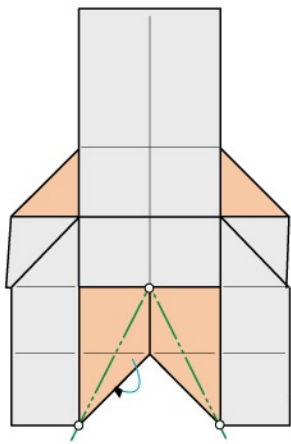

13

2 pieghe a monte

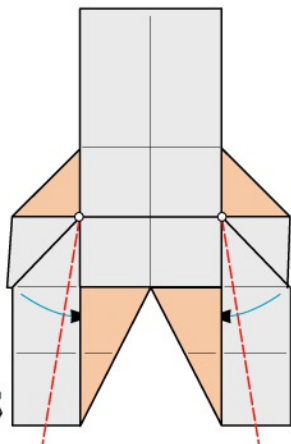

14

2 pieghe a valle

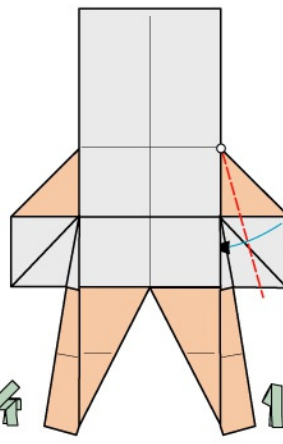

15

1 piega a valle

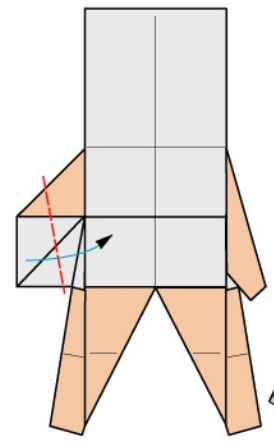

16

1 piega a valle

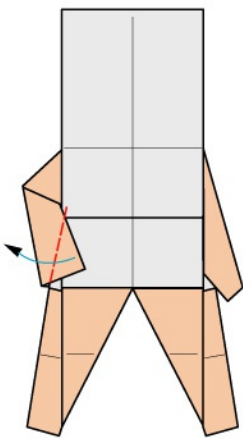

17

1 piega a valle

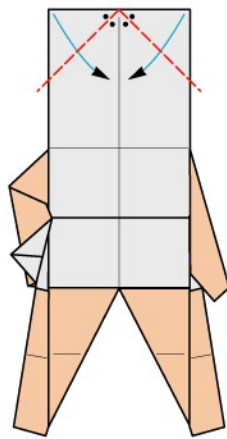

18

2 pieghe bisettrici a valle

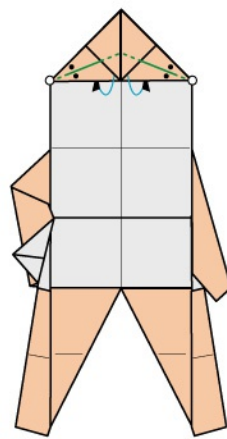

19

2 pieghe bisettrici a monte

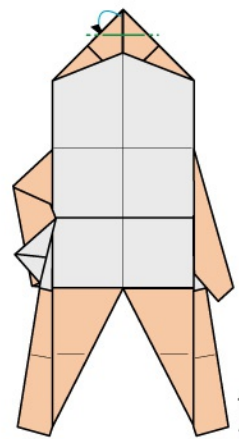

20

1 piega a monte

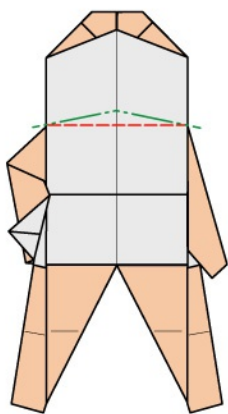

21

1 piega a monte e
ripiegate a valle

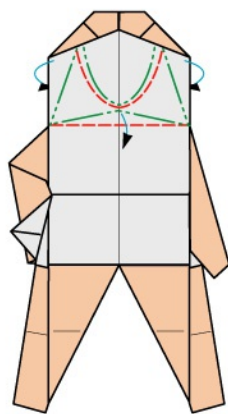

22

3 pieghe a monte,
2 a valle e ripiegate

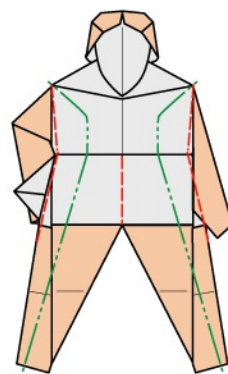

23

2 pieghe a monte,
3 a valle e ripiegate 3D

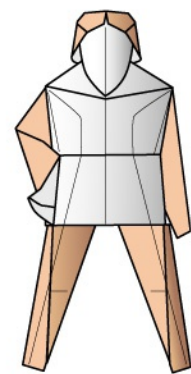

24

Guardiano ultimato

MANO APERTA



Adoperate un mezzo foglio quadrato monocoloro

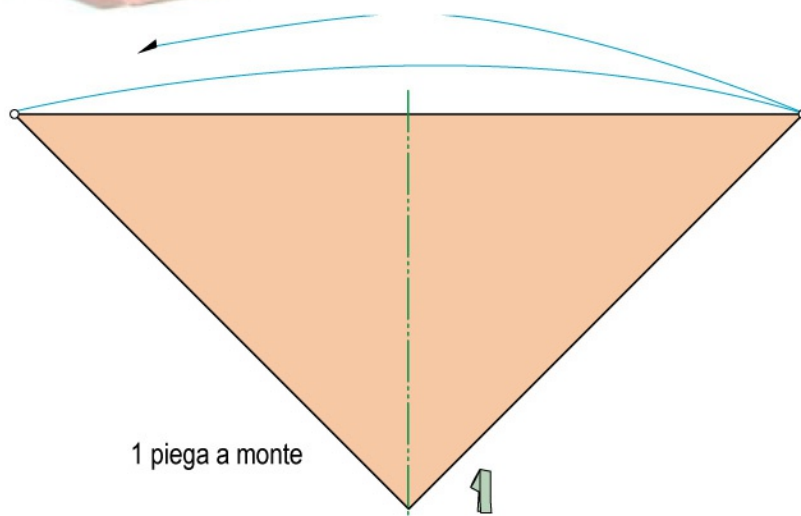

1 piega a monte

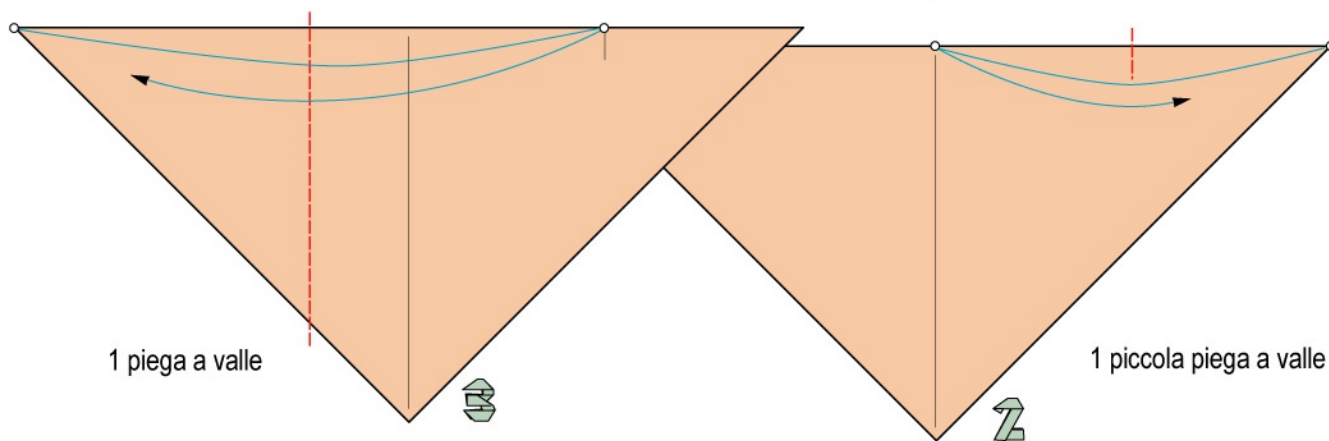

1 piega a valle

1 piccola piega a valle

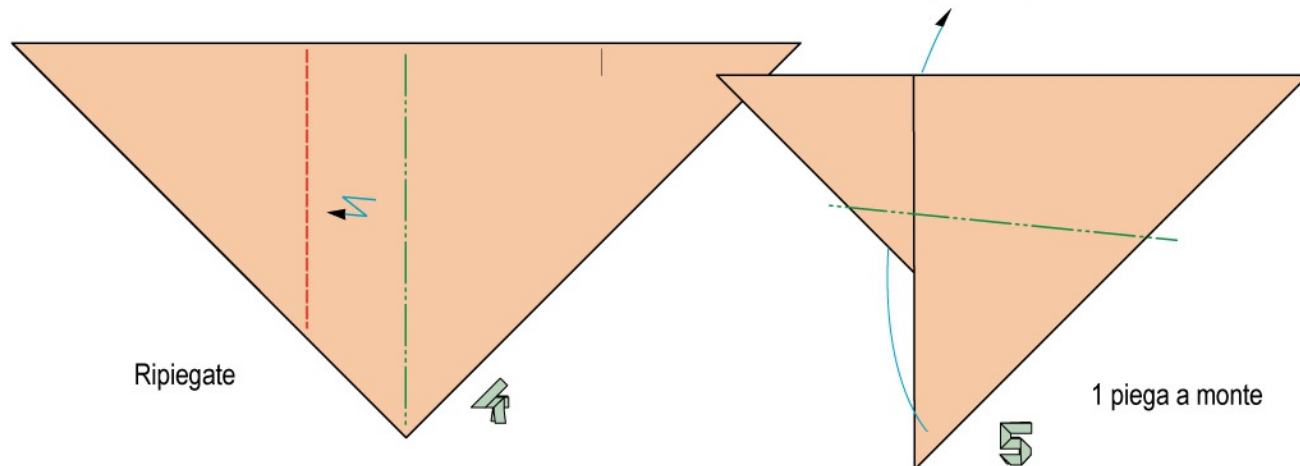

Ripiegate

1 piega a monte

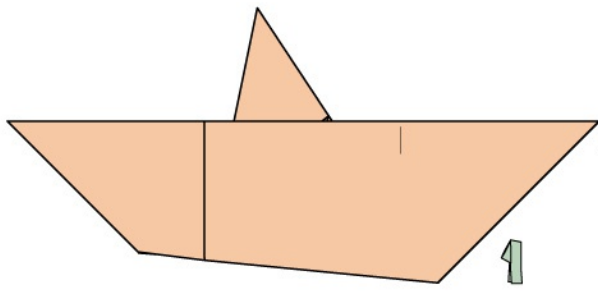

Riaprite tutto

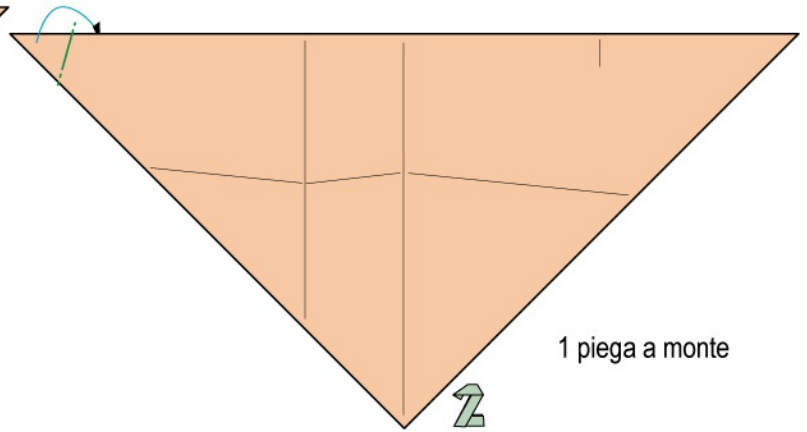

1 piega a monte

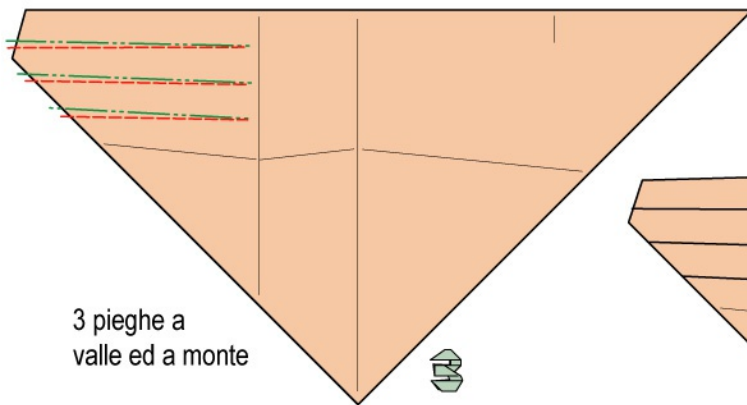

3 pieghe a valle ed a monte

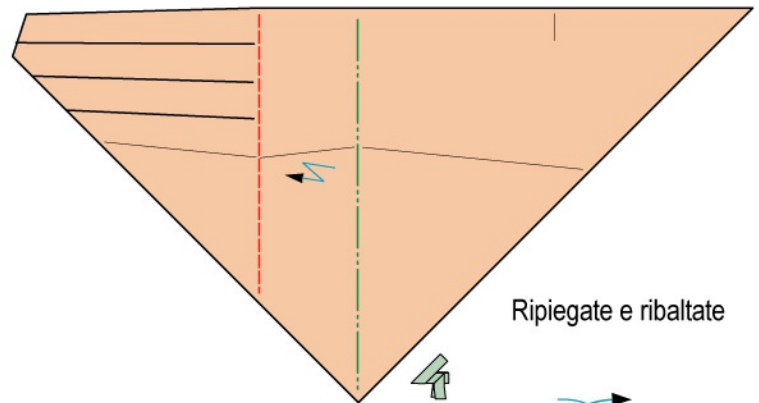

Ripiegate e ribaltate

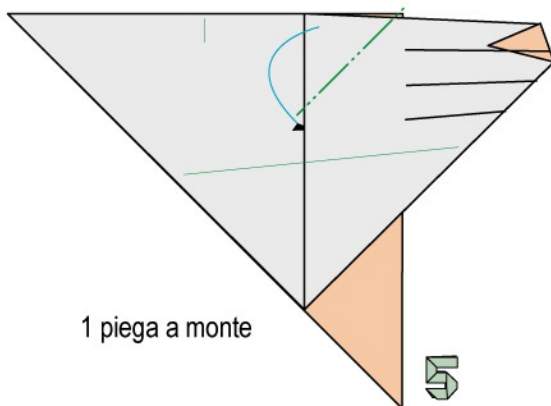

1 piega a monte

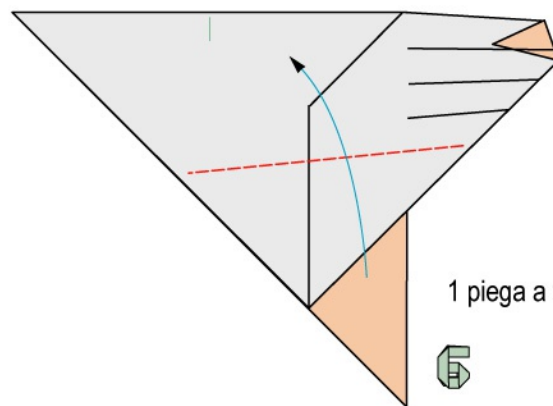

1 piega a valle

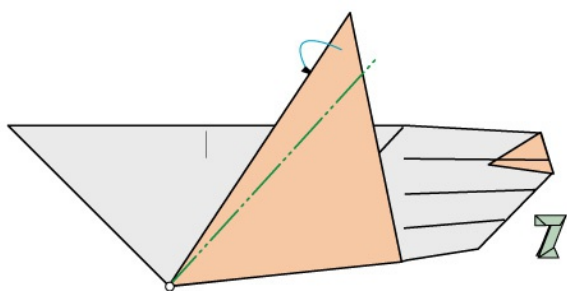

1 piega a monte

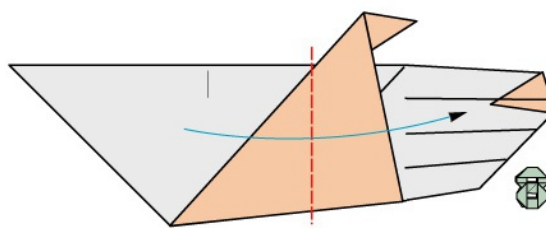

1 piega a valle

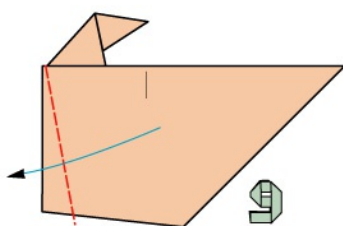

1 piega a valle

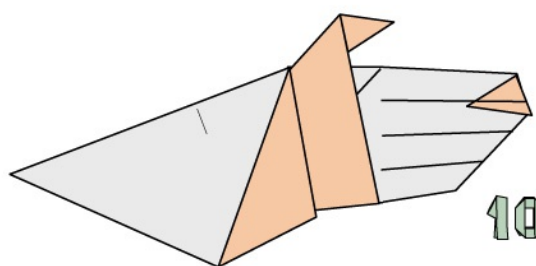

Ribaltate

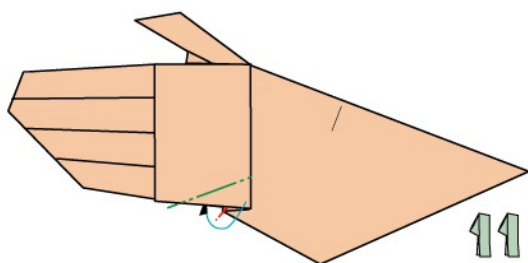

1 piega a monte

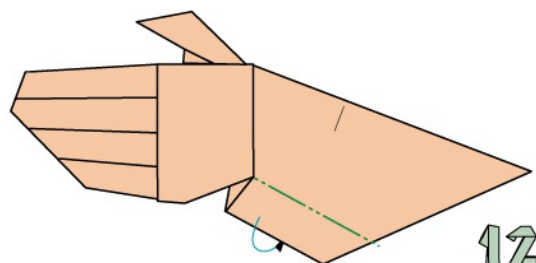

1 piega a monte

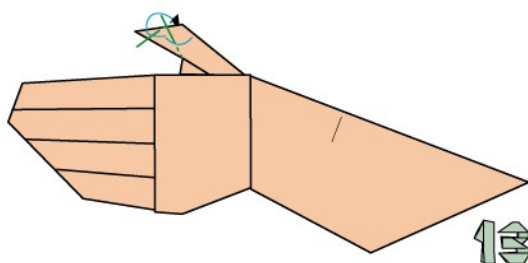

2 pieghe a monte

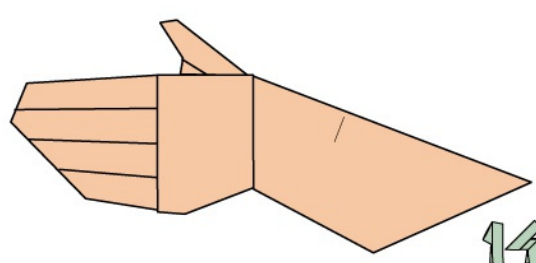

Mano aperta ultimata

MANO CHE INDICA

Adoperate un mezzo foglio quadrato monocoloro

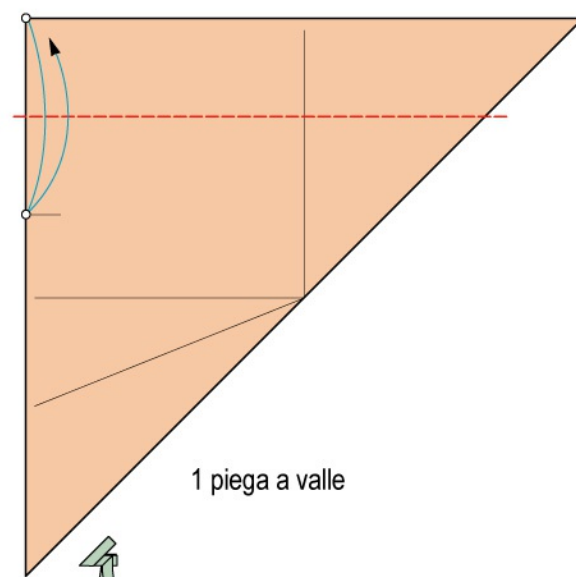
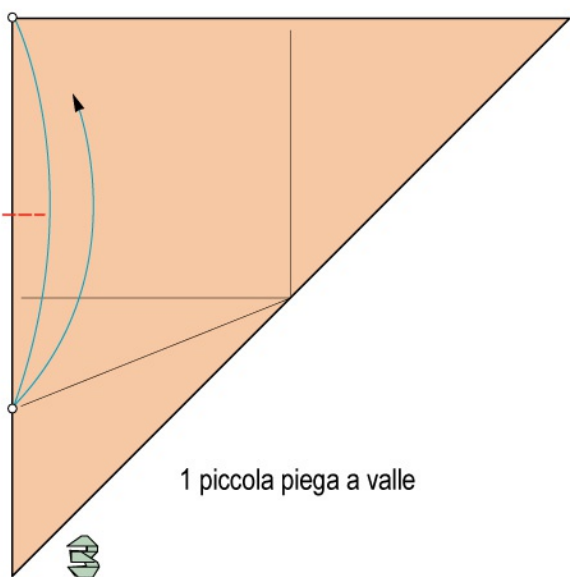
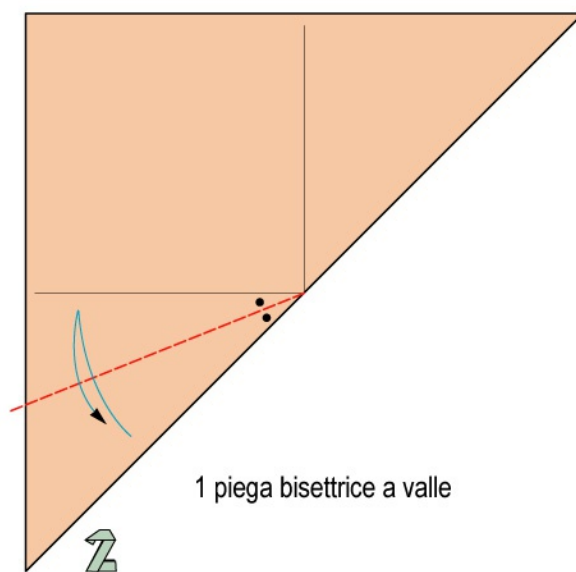
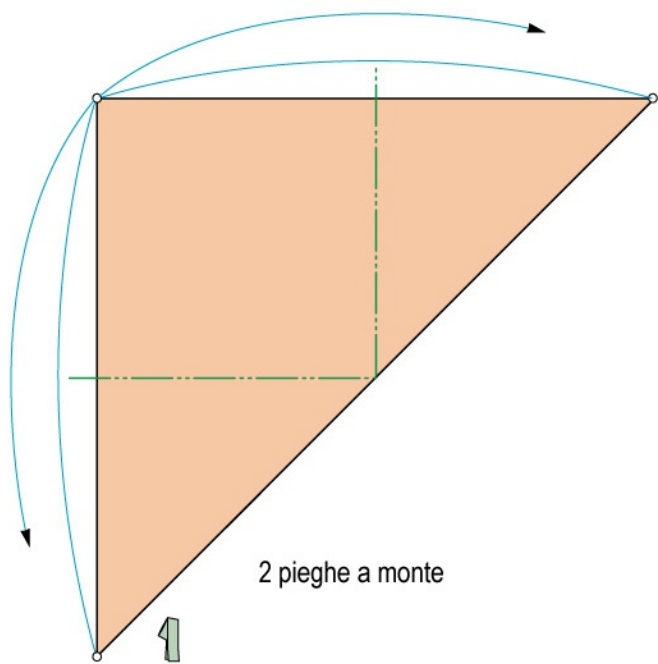

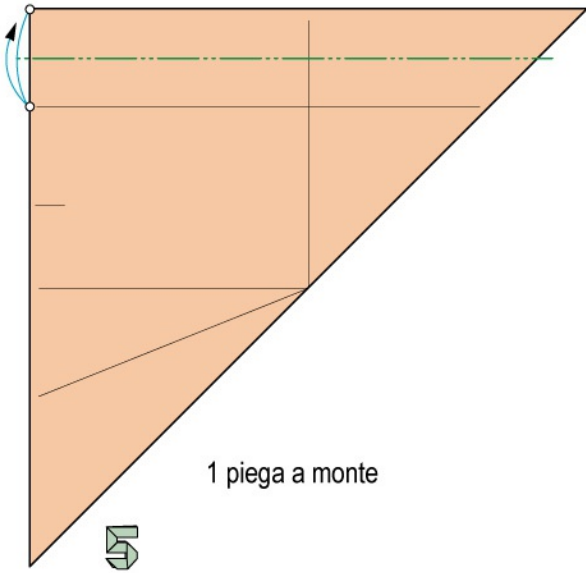

1 piega a monte

5

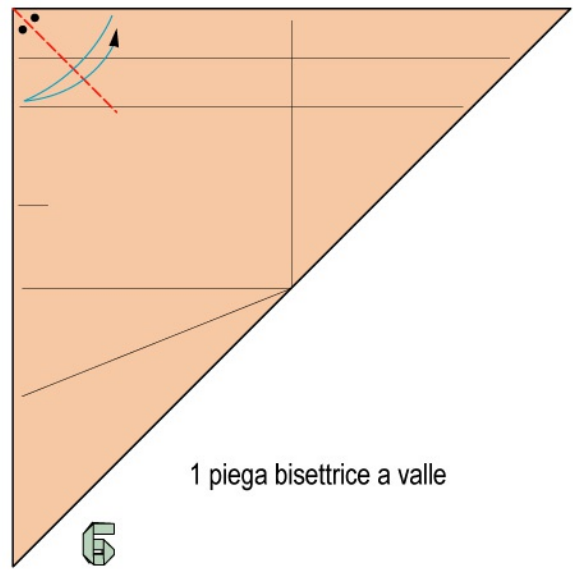

1 piega bisettrice a valle

6

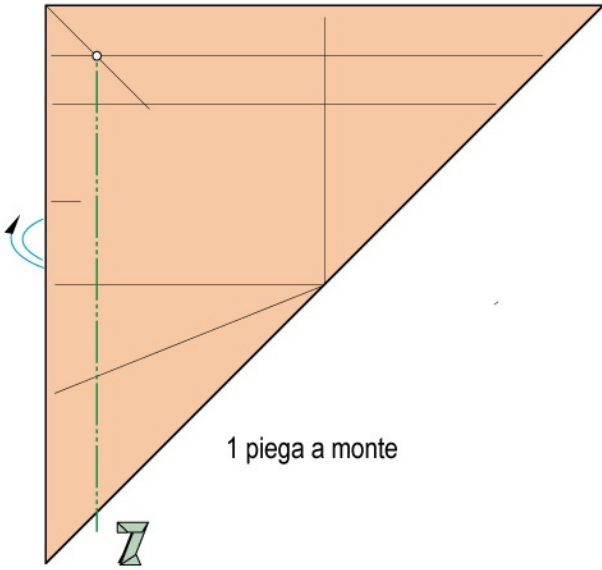

1 piega a monte

7

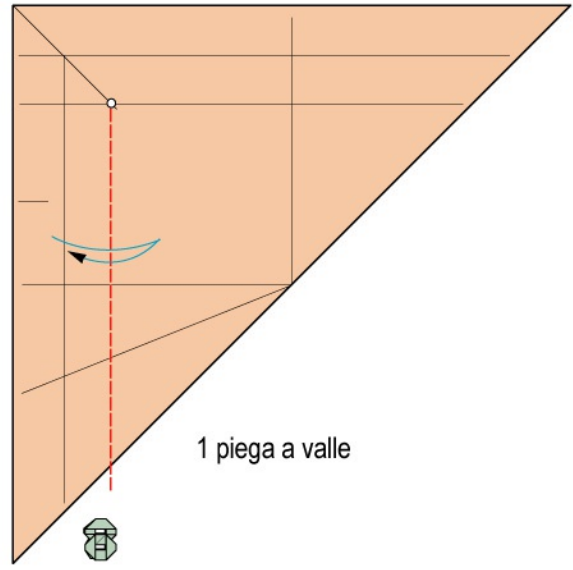

1 piega a valle

8

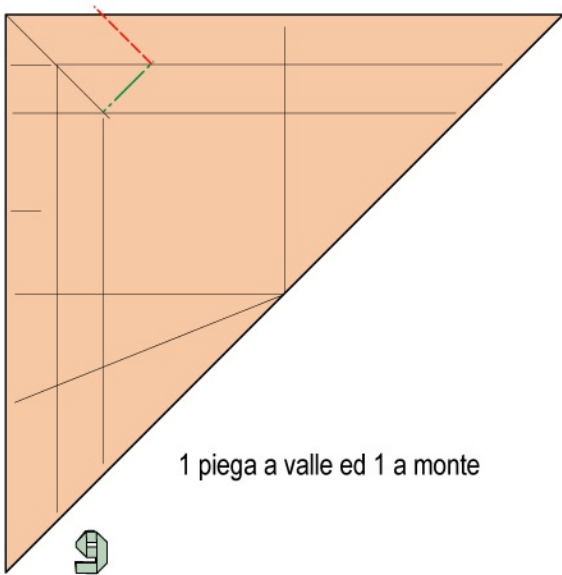

1 piega a valle ed 1 a monte

9

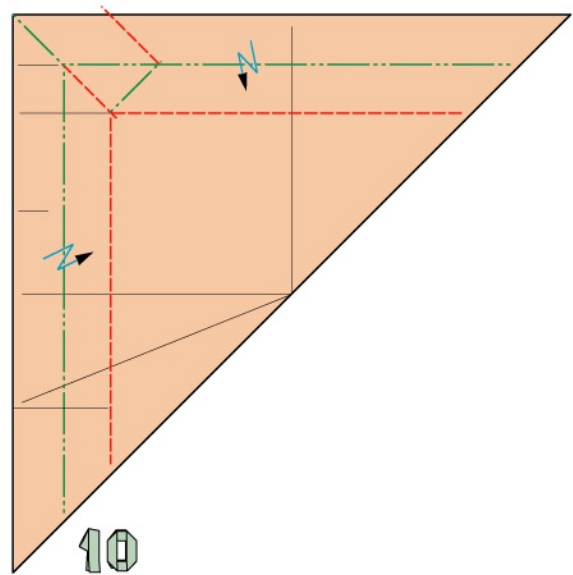

10

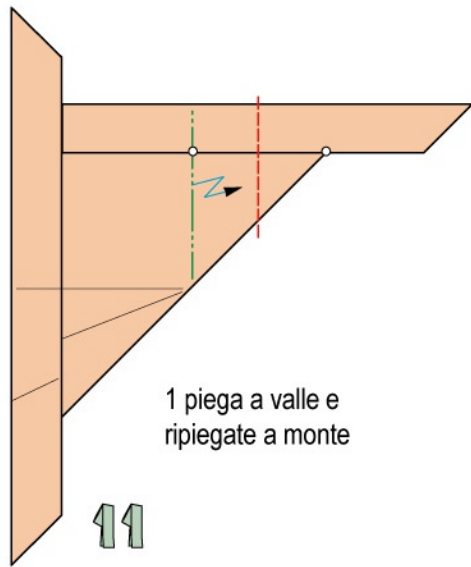

1 piega a valle e
ripiegate a monte

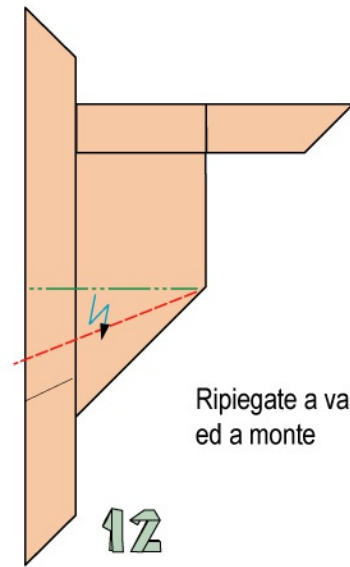

Ripiegate a valle
ed a monte

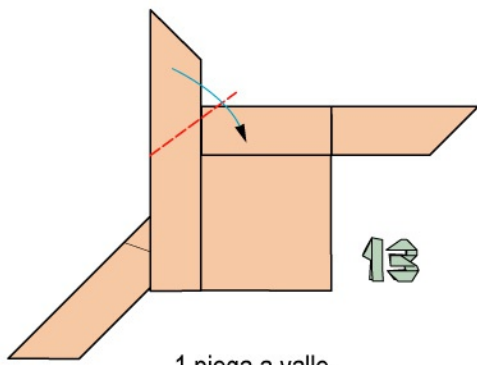

1 piega a valle

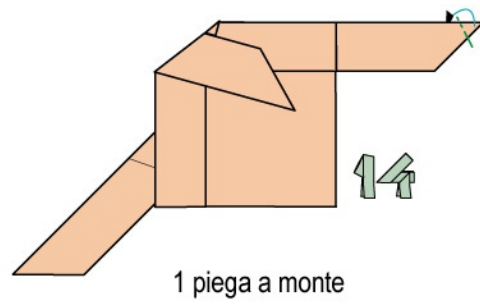

1 piega a monte

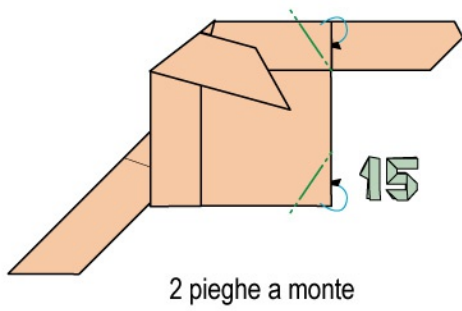

2 pieghe a monte

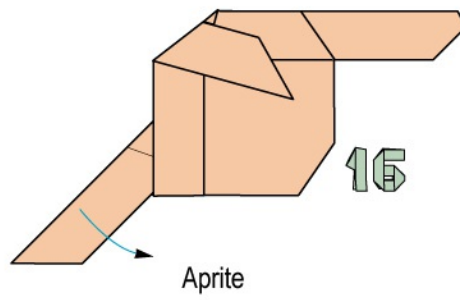

Aprite

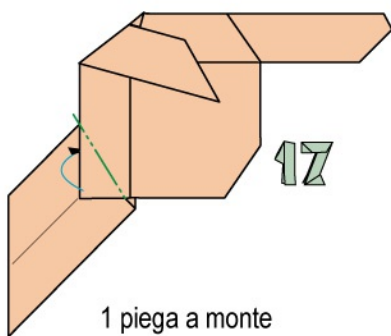

1 piega a monte

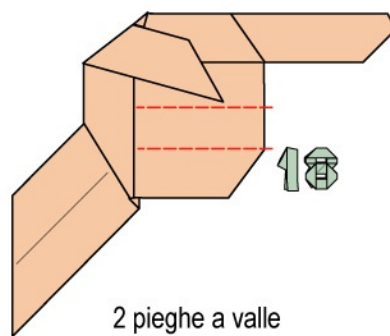

2 pieghe a valle

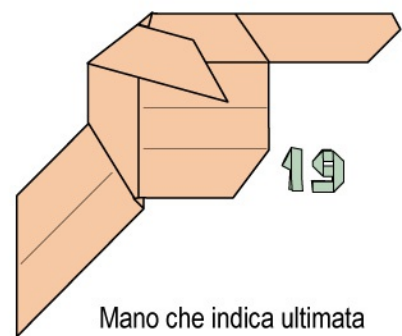

Mano che indica ultimata

Architetture 2D

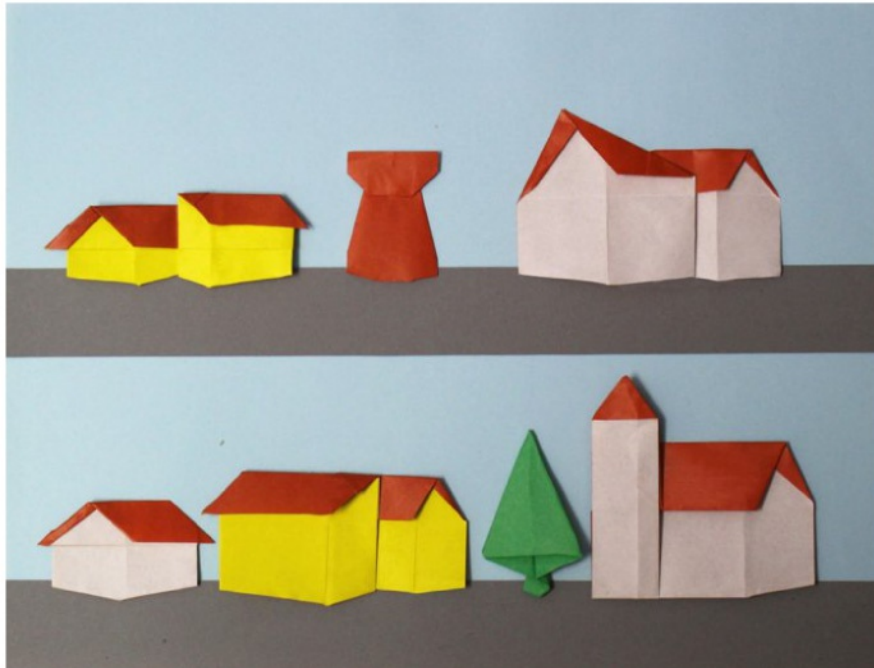

Per la costruzione di queste casette
occorrono fogli bicolori leggeri di
diverso formato, multipli fra loro

CHIESA

CASE A, B, C

ALBERO
CASETTA SINGOLA

TORRE

CASETTA

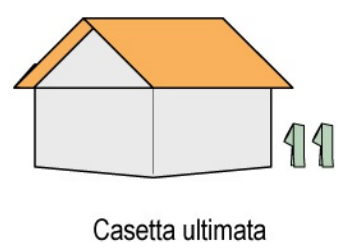
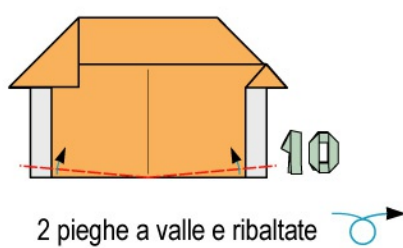
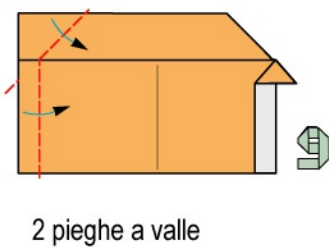
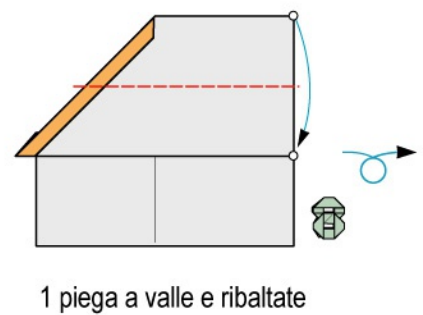
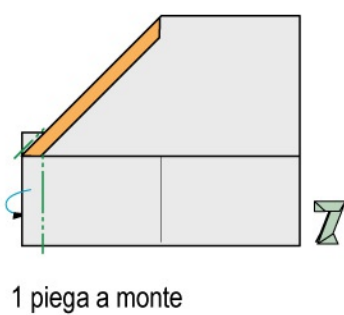
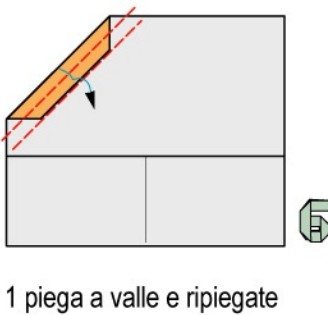
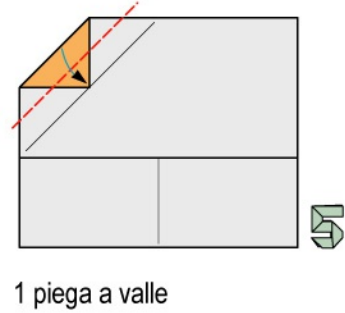
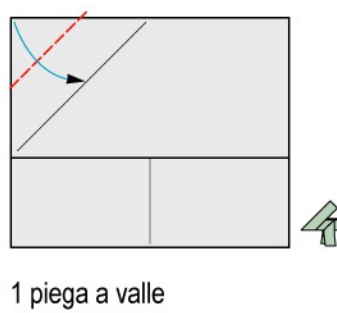
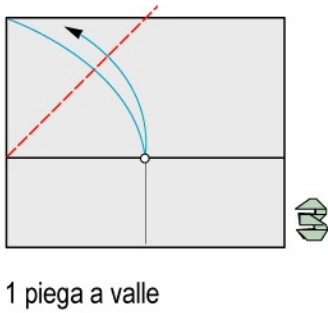
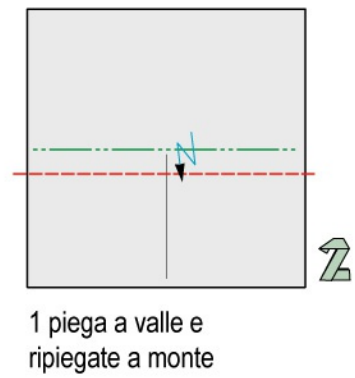
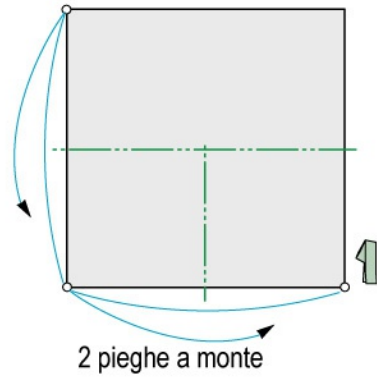

CHIESA

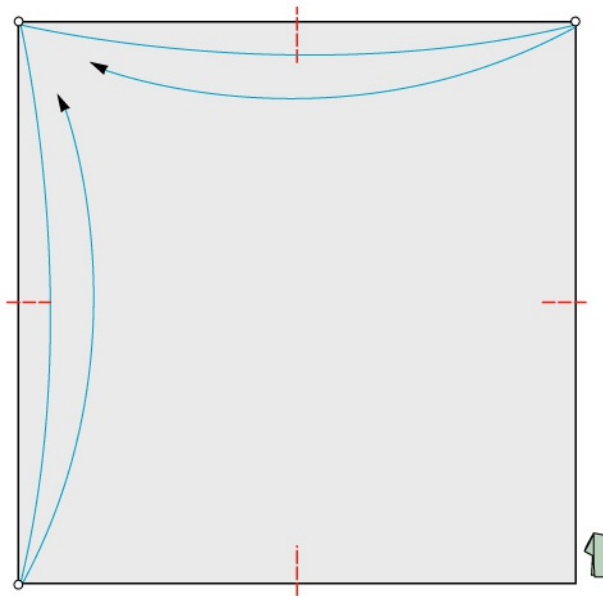

4 piccole pieghe a valle

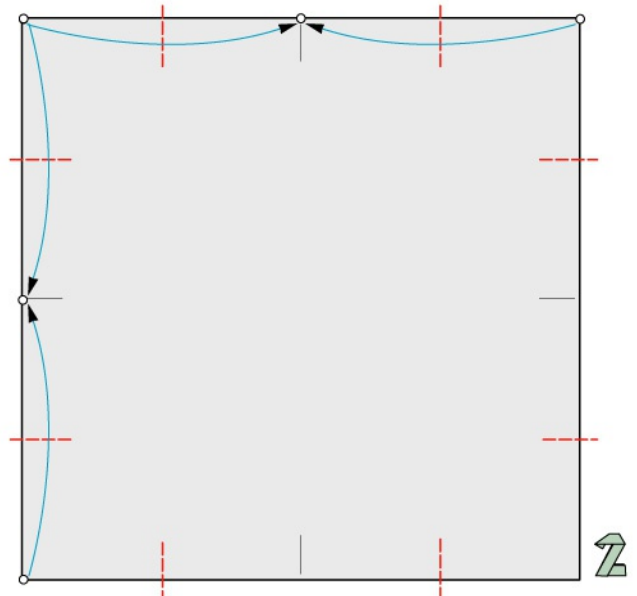

8 piccole pieghe a valle

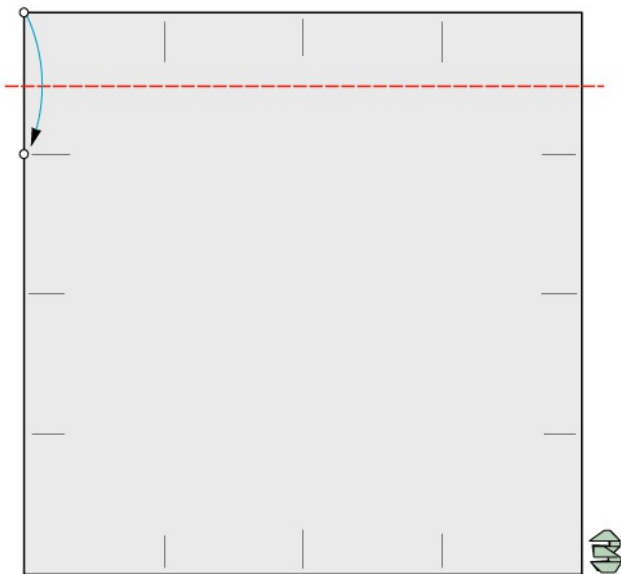

1 piega a valle

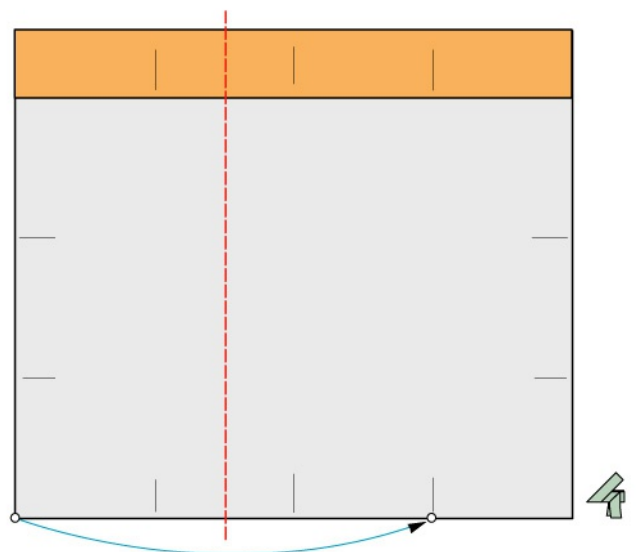

1 piega a valle

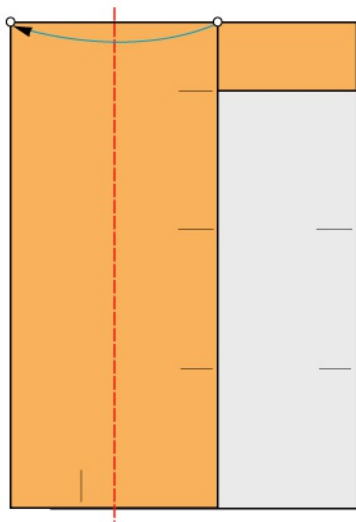

1 piega a valle

5

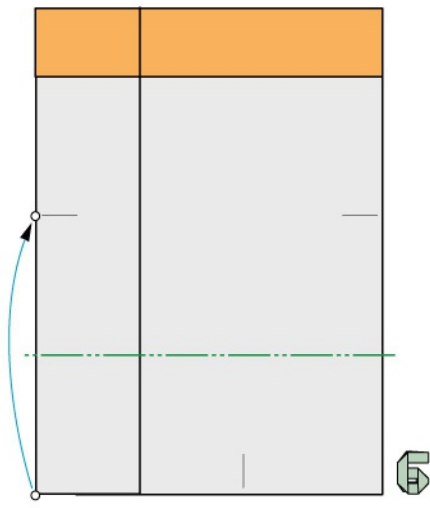

1 piega a monte e ribaltate

6

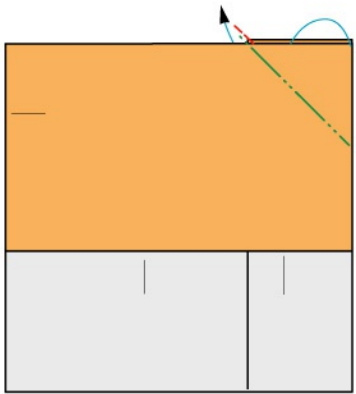

1 piega rovescia interna

7

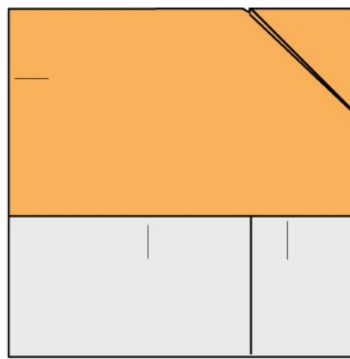

Ribaltate

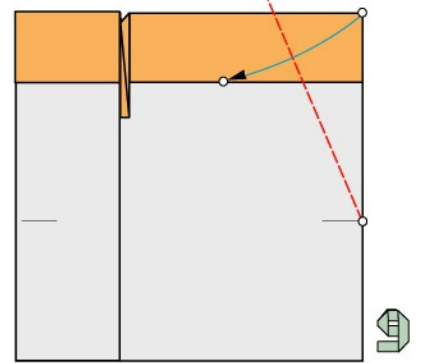

1 piega a valle

9

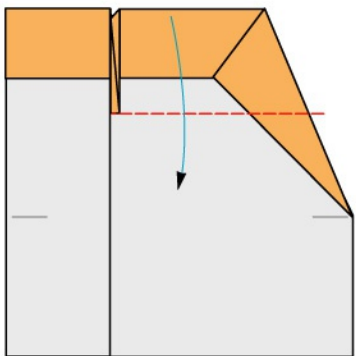

1 piega a valle

10

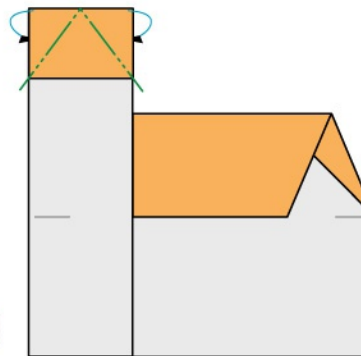

2 pieghe a monte

11

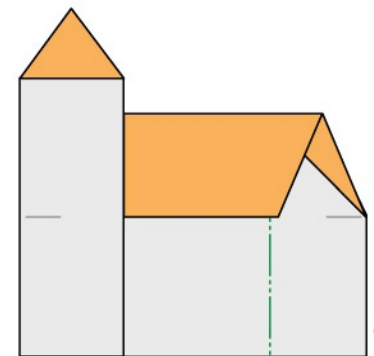

1 piega a monte

12

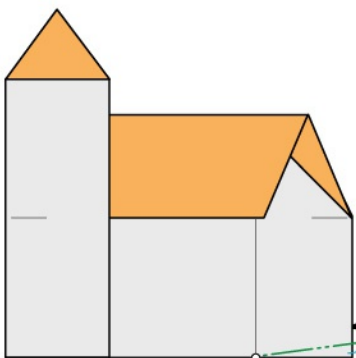

1 piega a monte

14

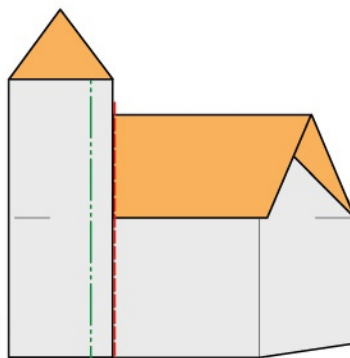

1 piega a monte e ripiegate a valle

15

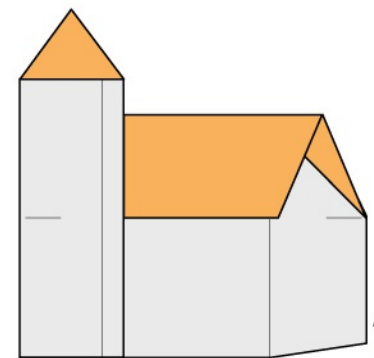

Chiesa ultimata

16

CASE "A"



1 piega a valle

1

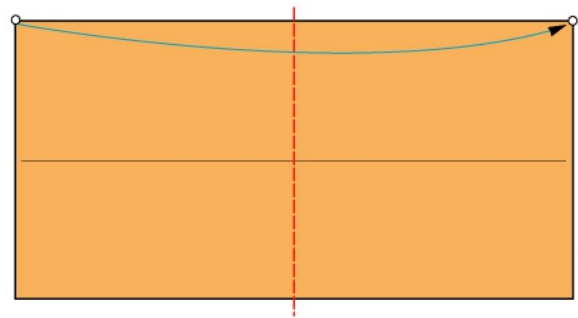

1 piega a valle

2

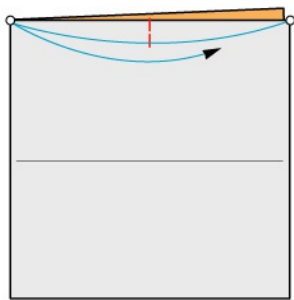

1 piccola piega a valle

3

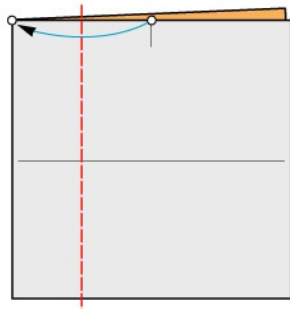

1 piega a valle

4

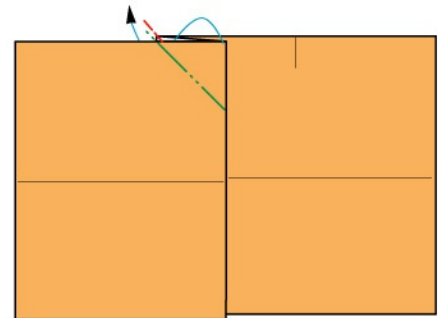

1 piega rovescia interna

5

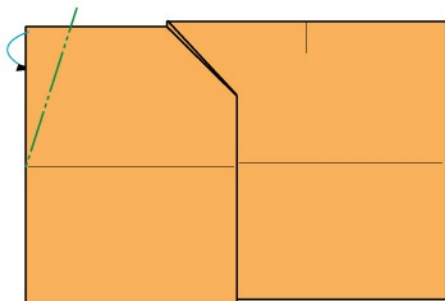

1 piega a monte

6

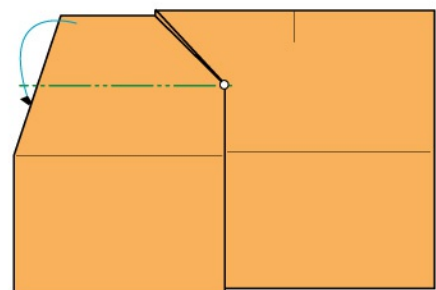

1 piega a monte

7

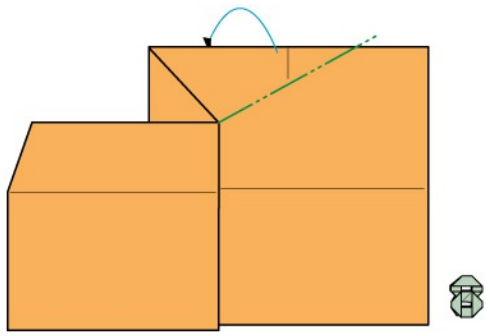

1 piega a monte e ribaltate

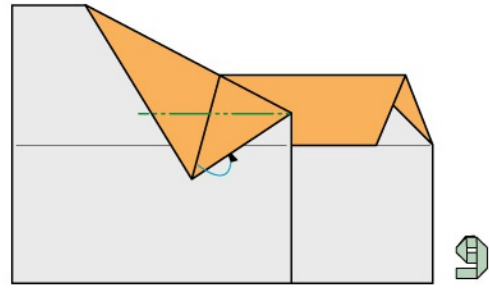

1 piega a monte

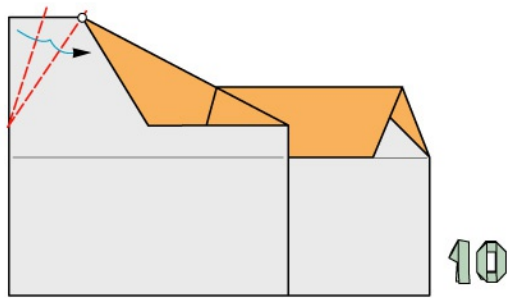

2 pieghe a valle

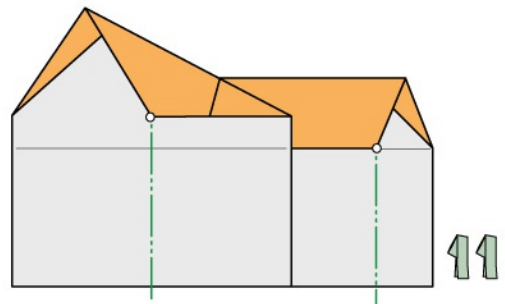

2 pieghe a monte

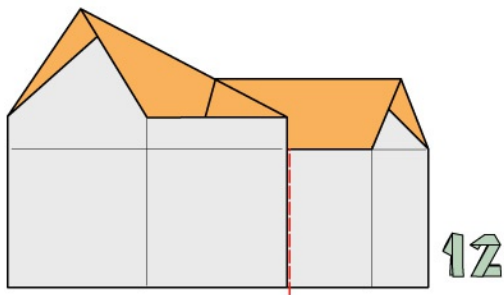

1 piega a valle

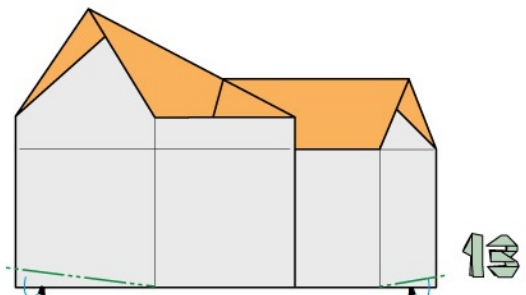

1 piega a monte

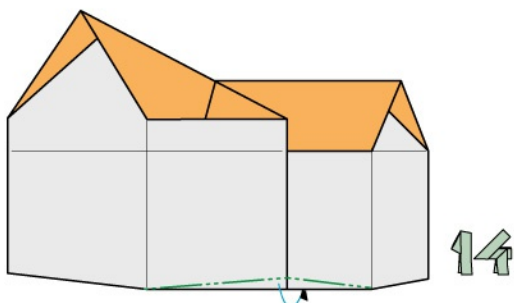

1 piega a monte

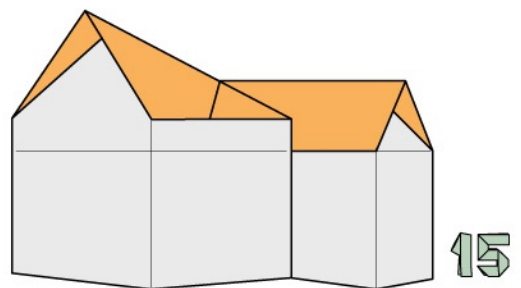

Case "A" ultimate

CASE "B"

Partite dalla fig. n. 7 delle case "A"

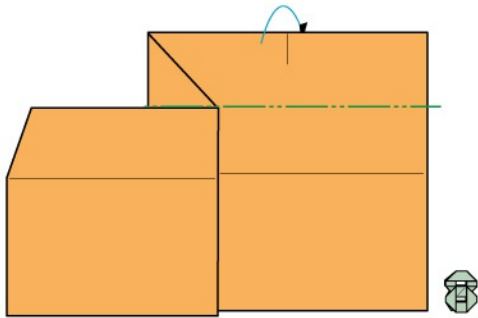

1 piega a monte

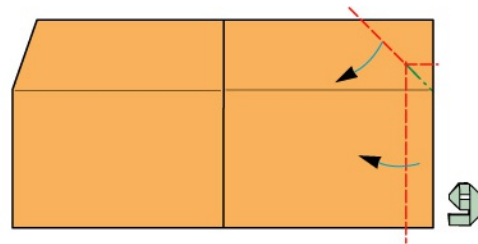

3 pieghe a valle ed 1 a monte

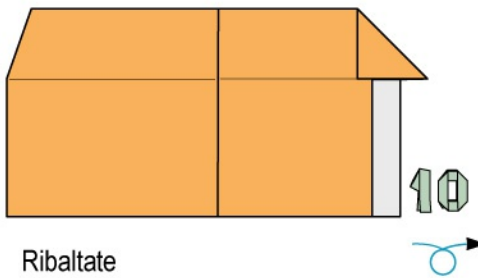

Ribaltate

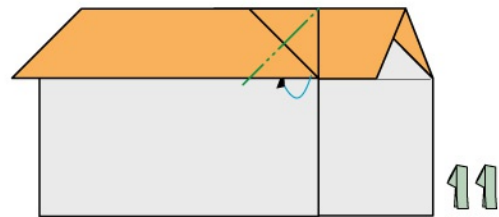

1 piega a monte



2 pieghe monte

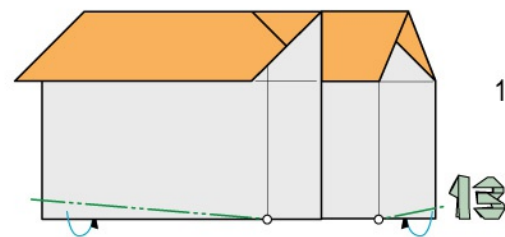

2 pieghe monte

1 piega a valle

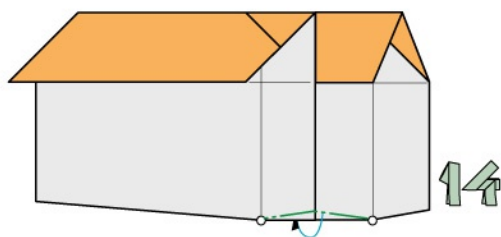

1 piega a monte

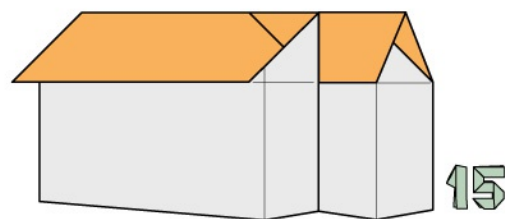

Case "B" ultimate



CASE "C"

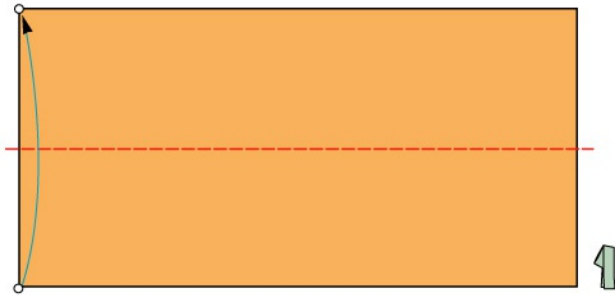

1 piega a valle



1 piega a valle



1 piega a valle

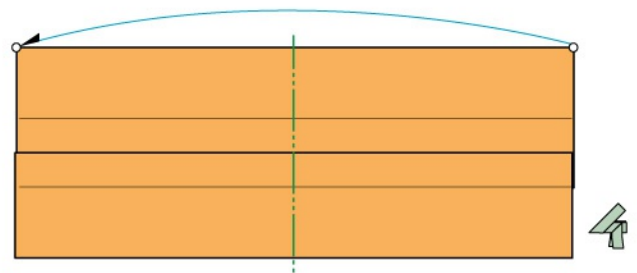

1 piega a monte

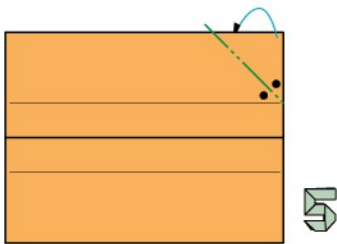

1 piega a monte

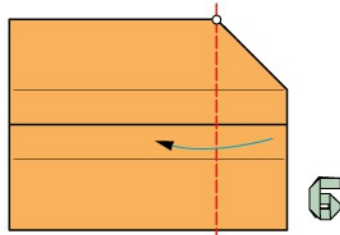

1 piega a valle

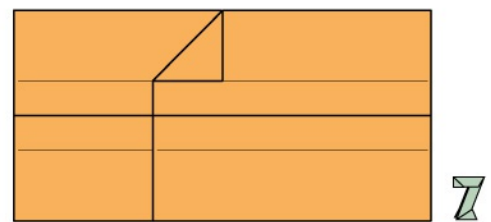

Ribaltate



1 piega bisettrice a valle



1 piega a monte

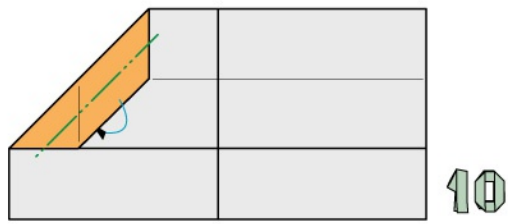

1 piega a monte

10

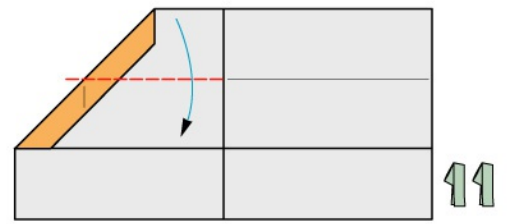

1 piega a valle

11

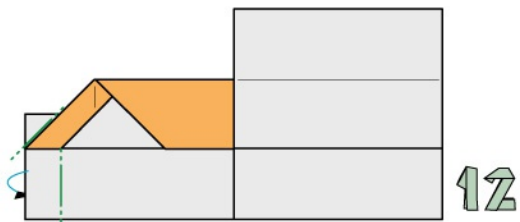

2 pieghe a monte

12

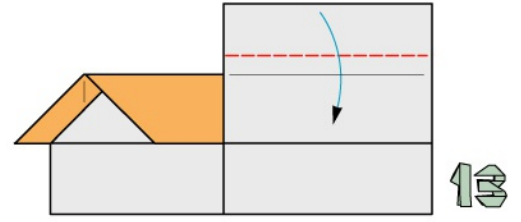

1 piega a valle

13

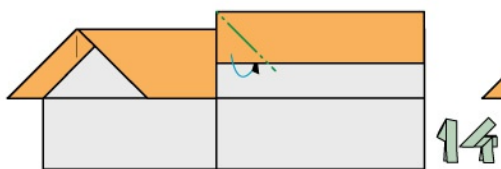

1 piega a monte

14

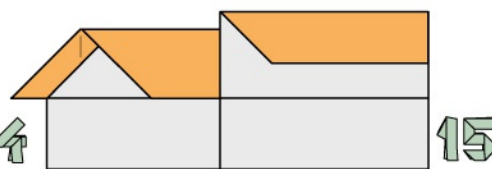

Ribaltate

15

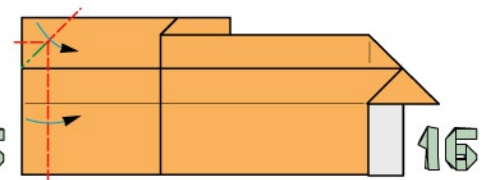

3 pieghe a valle ed 1 a monte

16

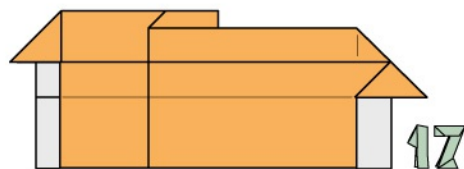

Ribaltate

17

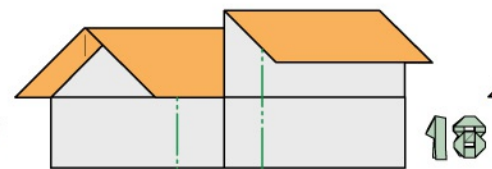

2 pieghe a monte

18

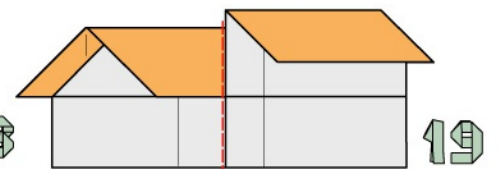

1 piega a valle

19



2 pieghe a monte

20

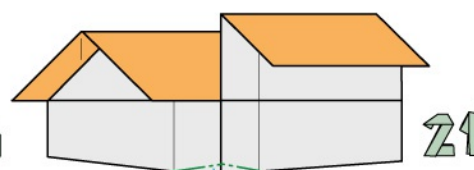

1 piega a monte

21

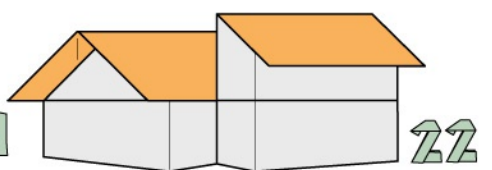

Case "C" ultimate

22

TORRE

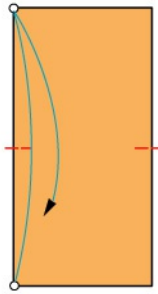

2 piccole pieghe a valle

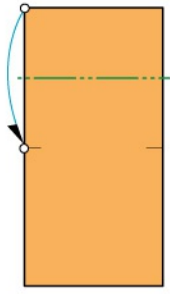

1 piega a monte

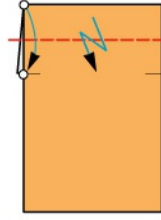

1 piega a valle

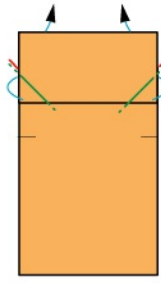

2 pieghe rovesce interne

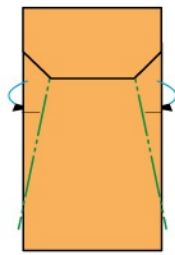

2 pieghe a monte

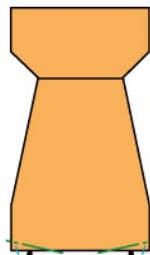

2 pieghe a monte

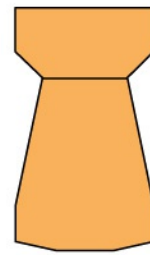

Torre ultimata



ALBERO

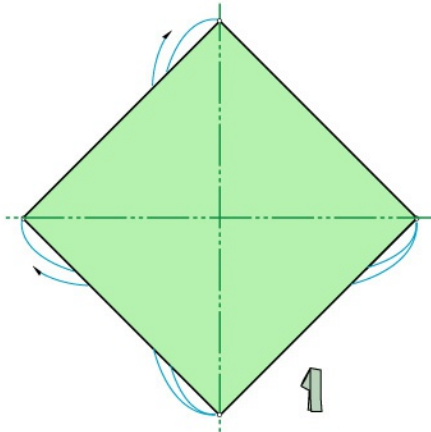

1

2 pieghe a monte

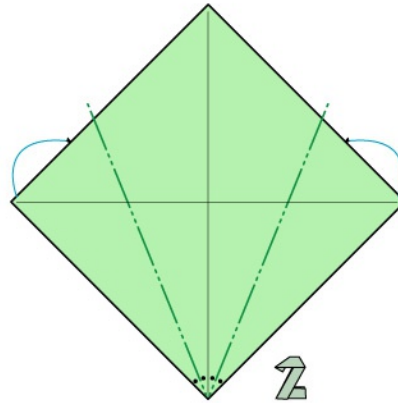

2

2 pieghe bisettrici a monte

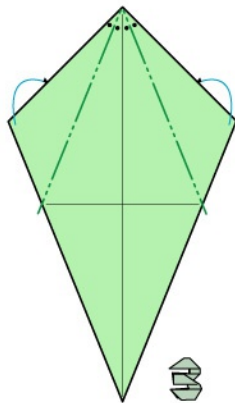

3

2 pieghe a monte

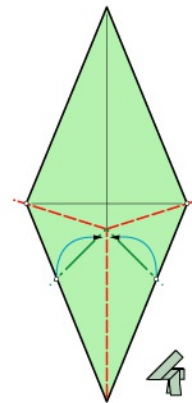

4

2 pieghe a valle, 2 a monte e ripiegate

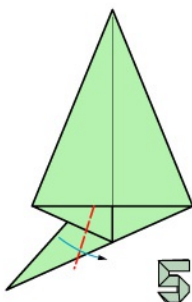

5

1 piega a valle

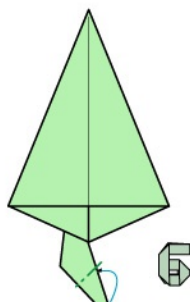

6

1 piega a monte

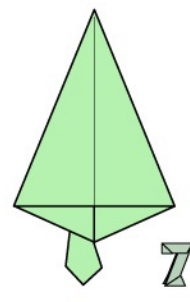

7

Albero ultimato

PUBBLICAZIONI DI FRANCO PAVARIN

Aerei , jet ed astronavi di carta volanti	IL CASTELLO	1986
Origami animati	“	1987
Origami maschere animate	”	1988
Decorazioni modulari con origami modulati	“	1989
Origami motoscafi navi barche e velieri	”	1990
Origami scatole e contenitori	“	1990
Pieghe forme e colori	”	1994
Aerei e navi di carta	FABBRI	1996
Fold and fly Paper airplanes	STERLING PUBLISHING	1998
Manuale rapido di aerei di carta volanti	FABBRI	2000
Aerei di carta 17 modelli volanti inediti	IL CASTELLO	2001
Aviones voladores	TUTOR S.A.	2003
17 modelos ineditos de aviones voladores	“	2004
Naves voladoras	”	2006
Quaderni Quadrato magico n.20 e 48	CDO	
Maschere, elmi e copricapi	web	2010
Maschere trasformabili	web	2011
21 nuovi aerei origami volanti	web	2014
Maschere origami 3D volume 1	web	2014
Maschere origami 3D volume 2	web	2015
Legorigami 1 -Q.Quadrato Magico n.56	CDO	2015
Composizione modulare 1	web	2016
Manuale dell'architetto origamista	web	2016
13 moduli origami aggregabili	web	2017
Alfabeti origami	web	2018
21 Elmi e strani copricapi origami	web	2019
Animaletti semplici origami	web	2020

